



PRODUCT
CATALOGUE
2024

**THEY DEFINE
BODYBUILDING.
WE DESIGN THE
BEST BODYBUILDING
MACHINES.**

**VIVA[®]
FITNESS**

#PushYourself

www.vivafitness.net



'Thoughts become things' when you leave the realm of average thinking and follow your dreams by applying the right decision, driven by your mind. Fitness is a 'state of mind', which needs constant trigger to put ones thought into action.

Every action needs a reason for accomplishing it. Staying fit manifests in the physicality and inner well-being which everyone aspires. Every time you make a resolve and step-up your fitness goals, life gets the better of you and positive thoughts lead to positive outcomes.

VIVA Fitness is an accomplished brand in the world of fitness equipment, designed for both commercial and home use. It thrives on the belief that with the right set of tools, a fitter person is better off in accomplishing his personal and professional goals.

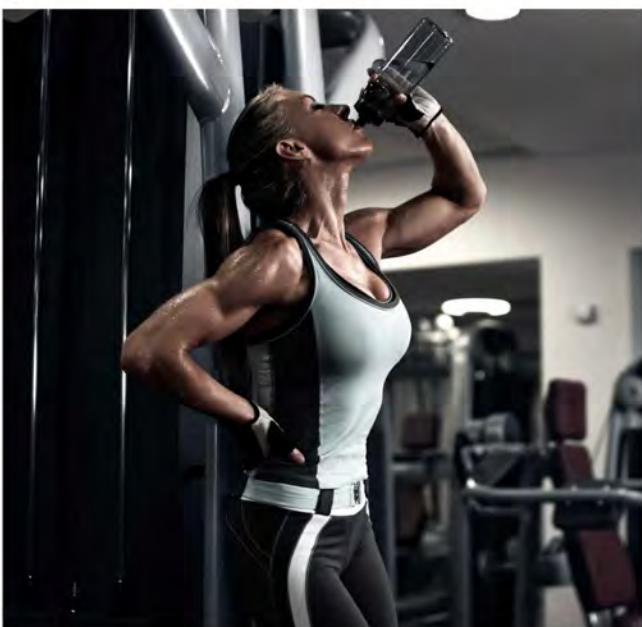

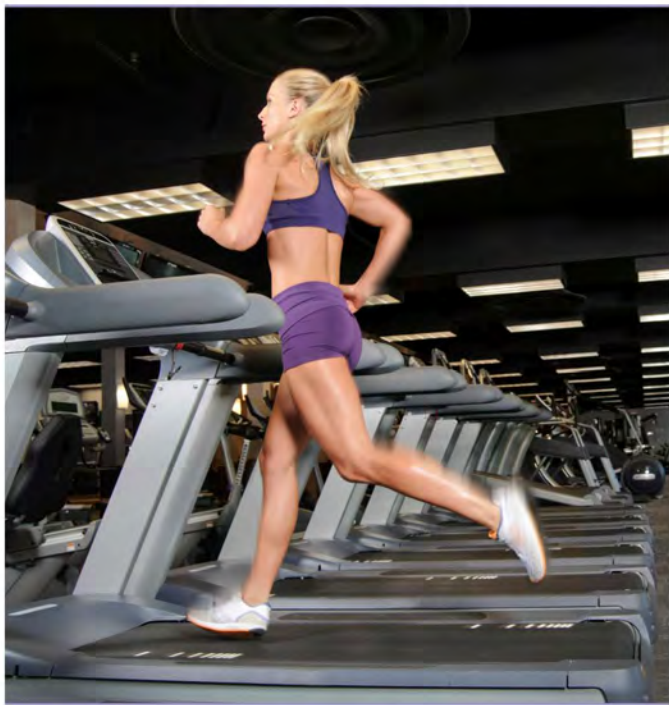

VIRTUAL X

COMMERCIAL TREADMILL



SPECIFICATIONS

- **21.5" HD TFT Screen with different landscape programs.**
- **Supports Wi-Fi connection & web browsing.**
- AC driving system with adjustable variable frequency.
- 4.0 HP AC continuous (8.0 HP Peak) motor.
- 23" x 64" running surface.
- Speed : 1~20 kmph.
- Precise incline control from 0~15%.
- With intelligent inverter that detects speed variation and adjust automatically.
- Direct speed & incline keys on the console.
- Various motivating programs for different workout requirements.
- Extra heavy duty steel base with double cell neoprene rubber system for excellent suspension.
- 1" thick fibre board running deck.
- **With cordless mobile charger.**
- Heavy duty reliable 2 ply commercial grade German Siegling running belt.
- Large sized twin cup holder with a built-in tray.
- Emergency stop button.
- Sweat proof console design.
- Maximum User Weight : 180 Kgs.
- LXWXH : 223X95X160 CM.



GENESIS 9i

COMMERCIAL TREADMILL

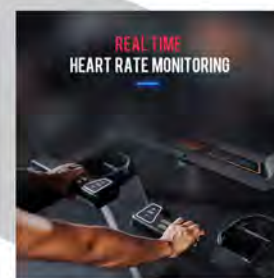

SPECIFICATIONS

- 27" capacitive touch screen with 1920x1080 HD resolution display.
- Supports Wi-Fi connection and web browsing.
- Durable AC motor driving system with over-current, short-circuit and comprehensive protection function
- 5.0 HP AC continuous (10.0 HP Peak) motor.
- 25" x 67" running surface.
- Speed : 1~25 kmph.
- Precise incline control from -3~18%.
- **Unique - 3% declinable deck.**
- Equipped with an automatic lubrication system.
- Direct speed & incline keys on the console.
- Built-in 24 motivating programs for different workout requirements.
- Extra heavy duty steel base with double cell neoprene rubber system for excellent suspension.
- 1" thick fibre board running deck.
- **With cordless mobile charger.**
- Heavy duty reliable 2 ply commercial grade German Siegling running belt.
- Large sized twin cup holder with a built-in tray.
- Emergency stop button.
- Sweat proof console design.
- Maximum User Weight : 200 Kgs.
- LXWXH : 221X98X176 CM.



T6000

COMMERCIAL TREADMILL



SPECIFICATIONS

- AC driving system with adjustable variable frequency.
- 5.0 HP AC continuous (10 HP Peak) motor.
- 22.5" x 64" running surface.
- Speed 1~25 kmph.
- Precise incline control from 0~20%.
- 16 x 24 cm Dot Matrix & alpha numerical display showing time, speed, distance, incline, calories & heart rate
- Direct speed & incline keys on the console
- Various motivating programs for different workout requirements.
- Double phenolic heavy cushioned deck for excellent shock absorption that provides suitable push off to reduce the possibility of any type of injury to knees and joints.
- Heavy duty reliable orthopaedic running belt.
- Built in speakers
- Sweat proof console design.
- Two Cup / Mobile Holders.
- Maximum User Weight : 200 Kgs.
- LXWXH : 218X97X163 CM

INNOVATIVE FEATURES



End cap & roller protect guide

- End cap installed with safety device for protection of user.



Safe key

- The emergency key with clip
- The user can also push center emergency button.



Grip

- Big, wide and smooth handle feel.
- Wide space structure so that user can work out freely and easily.
- Polyurethane sweat proof material.



Heart rate

- Intelligent heart rate system.
- Comfortable measure of heart rate.

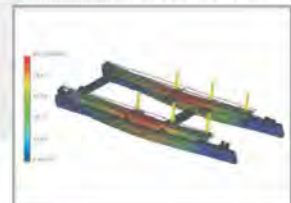

Frame

- Steady elevation system.
- Minimum noise system.
- Advance technology for stable and durable frame.



GENESIS 9

COMMERCIAL TREADMILL

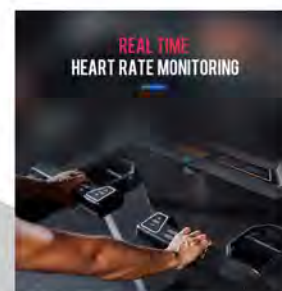

SPECIFICATIONS

- 7 window bright LED display.
- Durable AC motor driving system with over-current, short-circuit and comprehensive protection function
- 5.0 HP AC continuous (10.0 HP Peak) motor.
- 25" x 67" running surface.
- Speed : 1~25 kmph.
- Precise incline control from -3~18%.
- **Unique - 3% declinable deck.**
- Equipped with an automatic lubrication system.
- Direct speed & incline keys on the console.
- Built-in 24 motivating programs for different workout requirements.
- Extra heavy duty steel base with double cell neoprene rubber system for excellent suspension.
- 1" thick fibre board running deck.
- **With cordless mobile charger.**
- Heavy duty reliable 2 ply commercial grade German Siegling running belt.
- Large sized twin cup holder with a built-in tray.
- Emergency stop button.
- Sweat proof console design.
- Maximum User Weight : 200 Kgs.
- LXWXH : 221X98X176 CM.



T2222

COMMERCIAL TREADMILL



SPECIFICATIONS

- AC driving system with adjustable variable frequency.
- 4.0 HP AC continuous (8.0 HP Peak) motor.
- 21.5" x 62" running surface.
- Speed 1~25 kmph.
- Precise incline control from 0~15%.
- 7 LED display with dot matrix showing time, speed, distance, incline, calories, & heart rate.
- Direct speed & incline keys on the console.
- Various motivating programs for different workout requirements.
- Extra heavy duty steel base with double cell neoprene rubber system for excellent suspension.
- 1" thick fibre board running deck.
- Heavy duty reliable orthopaedic running belt.
- Large sized, twin cup holder with a built in tray to hold your mobile phone, MP3 and ipod.
- High speed O² generator.
- Emergency stop button.
- Sweat proof console design.
- Maximum user weight: 180 kg.
- LXWXH : 214X93X137 CM.



Q9i

COMMERCIAL TREADMILL



SPECIFICATIONS

- **21.5" HD TFT Screen with different landscape programs.**
- **Supports Wi-Fi connection & web browsing.**
- AC driving system with adjustable variable frequency.
- 5 HP AC continuous (10 HP Peak) external roto motor, high heat dissipation performance.
- 24" x 65" running surface.
- Speed 0.5-25kmph.
- Precise incline control from 0-20%.
- Including key-press, with direct speed (3/6/9) & incline(3/6/9) on the TFT screen.
- 38 programs : HRC (4), custom (18), manual (1), target (3), fatburn (3), cardio (3), strength (5) & fat measuring program.
- Programs developed by TOORX in collaboration with medical institutions in Italy & refined over a decade of use.
- Comes with unique curved upright tube and handle bar.
- With USB, audio port, speaker & regular lubrication & replacement reminder.
- **With wireless charger.**
- Sweat proof console design.
- Large sized twin cup holder.
- Emergency stop button.
- Extra heavy duty running board supporting structure.
- Heavy duty reliable orthopaedic running belt.
- Durable and reliable aluminum side rails.
- With durable Japanese bearing in rollers.
- Maximum user weight: 200kg.
- LXWXH : 226x97x167 CM.



T5555

Signature Series

COMMERCIAL TREADMILL



SPECIFICATIONS

- AC driving system with adjustable variable frequency.
- 5.0 HP AC continuous (10.0 HP Peak) motor.
- 22.5" x 60" running surface.
- Speed 1~25 kmph.
- Precise incline control from 0~15%.
- 7 window LED display with dot matrix showing time, speed, distance, incline, calories, pace, heart rate etc.
- Direct speed & incline keys on the console.
- Various motivating programs for different workout requirements.
- Extra heavy duty steel base with double cell neoprene rubber system for excellent suspension.
- 1" thick reversible running deck.
- Heavy duty reliable orthopaedic 2.3mm running belt.
- Large sized, twin cup holder with a built in tray to hold your ipad, mobile phone or magazine.
- With USB charger.
- Emergency stop button.
- Sweat proof console design.
- Maximum user weight: 180 kg.
- LXWXH : 211X95X157 CM



Intuitive LED console display with one-touch speed and incline keys.



Continuous multi-grip handlebars offer runner with countless hand-position options



A-Zone allows runners make quick and easy choices.



The bright lights underneath the handlebar indicate the treadmill's status by different colors.



T3300

COMMERCIAL TREADMILL



SPECIFICATIONS

- AC driving system with adjustable variable frequency.
- 4.5 HP AC continuous (9.0 HP Peak) motor.
- 24" x 65" running surface.
- Speed 0.8~25 kmph.
- Precise incline control from -3~18%
- **Unique -3% declinable deck**
- 6 LED display with dot matrix showing time, speed, distance, incline, calories, heart rate, steps, pace & average speed .
- Direct speed & incline keys on the console.
- Various motivating programs for different workout requirements.
- Extra heavy duty steel base with double cell neoprene rubber system for excellent suspension.
- 1" thick fibre board running deck.
- Heavy duty reliable orthopaedic running belt.
- Large sized, twin cup holder with a built in tray to hold your mobile phone,
- With USB charging point.
- High speed O² generator.
- Emergency stop button.
- Sweat proof console design.
- Maximum user weight: 180 kg.
- LXWXH : 221X103X168 CM



T2525

COMMERCIAL TREADMILL



SPECIFICATIONS

- AC driving system with adjustable variable frequency.
- 4.5 HP AC continuous (9.0 HP Peak) motor.
- 23" x 67" running surface.
- Speed 1~22 kmph.
- Precise incline control from 0~15%
- 7 LED display with dot matrix showing time, speed, distance, incline, calories, heart rate, steps.
- Direct speed & incline keys on the console.
- Various motivating programs for different workout requirements.
- Extra heavy duty steel base with double cell neoprene rubber system for excellent suspension.
- 1" thick fibre board running deck.
- Heavy duty reliable orthopaedic running belt.
- Large sized, twin cup holder with a built in tray to hold your mobile phone.
- With USB charging point.
- MP3 connectivity with speakers.
- Emergency stop button.
- Sweat proof console design.
- Maximum user weight: 180 kg.
- LXWXH : 228X104X162 CM.



Q7i

COMMERCIAL TREADMILL



SPECIFICATIONS

- **15.6" HD TFT Screen with different landscape programs.**
- **Supports Wi-Fi connection & web browsing.**
- AC driving system with adjustable variable frequency.
- 4.5 HP AC continuous (9.0 HP Peak) external roto motor, high heat dissipation performance.
- 24"x63" running surface.
- Speed 1-22kmph.
- Precise incline control from 0-15%.
- Including key-press, with direct speed (3/6/9) & incline (3/6/9) on the TFT screen.
- Various motivating programs for different workout requirements.
- With USB & audio interface.
- **With wireless charger.**
- Sweat proof console design.
- Large sized twin cup holder.
- Emergency stop button.
- Extra heavy duty running board supporting structure.
- Heavy duty reliable orthopaedic running belt.
- With durable Japanese bearing in rollers.
- Maximum user weight: 180kg.
- LXWXH : 210×93×161 CM.



T2020

COMMERCIAL TREADMILL



- SPECIFICATIONS**
- AC driving system with adjustable variable frequency.
 - 4.0 HP AC continuous (8.0 HP Peak) motor.
 - Speed : 1~20 kmph.
 - Precise incline control from 0 ~20%.
 - 23" x 60" running surface.
 - Multi window display showing time, speed, distance, incline, calories & heart rate.
 - Direct speed & incline keys on the console.
 - Various motivating programs for different workout requirements.
 - Double phenolic heavy cushioned deck for excellent shock absorption that provides suitable push off to reduce the possibility of any type of injury to knees and joints.
 - Heavy duty reliable orthopedic running belt.
 - Emergency stop button.
 - Sweat proof console design.
 - Two Mobile/Bottle Holders.
 - Maximum User Weight : 180 Kgs.
 - LXWXH : 220X91X162 CM.



Q5i

COMMERCIAL TREADMILL



SPECIFICATIONS

- **15.6" HD TFT Screen with different landscape programs.**
- **Supports Wi-Fi connection & web browsing.**
- AC driving system with adjustable variable frequency
- 4.0 HP AC continuous (8.0 HP Peak) external roto motor, high heat dissipation performance
- 23.6" x 63" (60*160cm) running surface
- Speed 1-22kmph
- Precise incline control from 0-15%
- Including key-press, with direct speed (3/6/9) & incline(3/6/9) on the TFT screen
- Various motivating programs for different workout requirements: quick start/ real scene mode (6) / target mode (3) / training mode (5) / HRC mode
- With USB & audio interface
- **With wireless charger**
- Sweat proof console design
- Large sized, twin cup holder to hold your mobile phone
- Emergency stop button
- Extra heavy duty running board supporting structure
- Heavy duty reliable orthopaedic running belt
- Maximum user weight : 180kg
- L X W X H : 210x93x161 cm



Q9

COMMERCIAL TREADMILL



SPECIFICATIONS

- AC driving system with adjustable variable frequency.
- 5 HP AC continuous (10 HP Peak) external roto motor, high heat dissipation performance.
- 24" x 65" running surface.
- Speed 0.5-25kmph.
- Precise incline control from 0-20%.
- 7LED+dot matrix display showing time, incline, speed, pace, calorie, distance, heart rate, step, METs, temperature etc.
- Medical grade silicon keys with direct speed (3/6/9) & incline (4/8/12) on the console.
- 38 programs : HRC (4), custom (18), manual (1), target (3), fatburn (3), cardio (3), strength (5) & fat measuring program.
- Programs developed by TOORX in collaboration with medical institutions in Italy & refined over a decade of use.
- Comes with unique curved upright tube and handle bar.
- With USB, audio port, speaker & regular lubrication & replacement reminder.
- Sweat proof console design.
- Large sized twin cup holder.
- Extra heavy duty running board supporting structure.
- Heavy duty reliable orthopaedic running belt.
- Durable and reliable aluminum side rails.
- With durable Japanese bearing in rollers.
- Maximum user weight: 200kg.
- LXWXH : 226×97×167 CM.



Q8

COMMERCIAL TREADMILL



SPECIFICATIONS

- AC driving system with adjustable variable frequency.
- 5 HP AC continuous (10.0 HP Peak) external roto motor, high heat dissipation performance.
- 24" x 65" running surface.
- Speed 0.5-25kmph.
- Precise incline control from 0-20%.
- 6 LED+dot matrix display showing time, incline, speed, pace, calorie, distance, heart rate, step, METs & temperature.
- Medical grade silicon keys with direct speed (3/6/9) & incline (4/8/12) on the console.
- Various motivating programs for different workout requirements.
- With USB & audio interface, USB can be used for charging.
- Sweat proof console design.
- Large sized twin cup holder.
- Emergency stop button.
- Extra heavy duty running board supporting structure.
- Heavy duty reliable orthopaedic running belt.
- With durable Japanese bearing in rollers.
- Maximum user weight: 180kg.
- LXWXH: 226×97×167 CM.



X10

COMMERCIAL TREADMILL



SPECIFICATIONS

- AC driving system with adjustable variable frequency.
- 4.0 HP AC continuous (8.0 HP Peak) motor.
- 23" x 62" running surface.
- Speed 0.8~20 kmph.
- Precise incline control from 0~18%
- **With cordless mobile charger.**
- 5 LED display with dot matrix showing time, speed, distance, incline, calories, heart rate, steps, pace & average speed .
- Direct speed & incline keys on the console.
- Various motivating programs for different workout requirements.
- Extra heavy duty steel base with double cell neoprene rubber system for excellent suspension.
- 1" thick fibre board running deck.
- Heavy duty reliable orthopaedic running belt.
- Large sized, twin cup holder with a built in tray to hold your mobile phone,
- With USB charging point.
- High speed O² generator.
- Emergency stop button.
- Sweat proof console design.
- Maximum user weight: 160 kg.
- LXWXH : 209X88X163 CM



Q3i

COMMERCIAL TREADMILL



SPECIFICATIONS

- **15.6" HD TFT Screen with different landscape programs.**
- **Supports Wi-Fi connection & web browsing.**
- AC driving system with adjustable variable frequency
- 3.0HP AC continuous (6.0HP Peak) external roto motor with high hear performance
- 22.44" x 59" running surface. Speed:1-20km/h
- Precise incline control from 0-15%
- Including key-press, with direct speed (3/6/9) & incline(3/6/9) on the TFT screen
- Various motivating programs for different workout requirements: quick start/ real scene mode (6) / target mode (3) / training mode (5) / HRC mode
- With USB & audio interface
- **With wireless charger**
- Sweat proof console design
- Large sized, twin cup holder to hold your mobile phone
- Emergency stop button
- Extra heavy duty running board supporting structure
- Durable Japanese bearing used in roller
- Max user weight : 150kg
- L X W X H : 197x93x145 cm



Q7

COMMERCIAL TREADMILL



SPECIFICATIONS

- AC driving system with adjustable variable frequency.
- 4.5 HP AC continuous (9.0 HP Peak) external roto motor, high heat dissipation performance.
- 24" x 63" running surface.
- Speed 1-22kmph.
- Precise incline control from 0-15%.
- 7 LED+dot matrix display showing time, incline, speed, pace, calorie, distance, heart rate, step, METs & temperature.
- Medical grade silicon keys with direct speed (3/6/9) & incline (4/8/12) on the console.
- Various motivating programs for different workout requirements.
- With USB & audio interface, USB can be used for charging.
- Sweat proof console design.
- Large sized twin cup holder.
- Emergency stop button.
- Extra heavy duty running board supporting structure.
- Heavy duty reliable orthopaedic running belt.
- With durable Japanese bearing in rollers.
- Maximum user weight: 180kg.
- LXWXH: 210×93×161 CM.



T1919

COMMERCIAL TREADMILL



SPECIFICATIONS

- AC driving system provides higher torque of power for heavy loading
- 4.0 HP AC continuous (8.0 HP Peak) motor
- 23.6" x 63" running surface
- Speed 1~22 kmph
- Precise incline control from 0~15%
- Clear & luxurious design, 6 window LED display showing time, speed, incline, calories, distance, program & heart rate
- Various motivating programs for different workout requirements
- 6 PCS rubber cushion for excellent shock absorption that provides suitable push off to reduce the possibility of most of injury to knees and joints
- Heavy duty 2.5mm reliable orthopedic running belt
- MP3 connected with speakers, blue tooth music and Fit show App
- Sweat proof console design
- Two cup / bottle holders
- Maximum User Weight: 180 kgs
- LXWXH : 201X92X159 CM.



Q5

COMMERCIAL TREADMILL



SPECIFICATIONS

- AC driving system with adjustable variable frequency.
- 4.0 HP AC continuous (8.0 HP Peak) external roto motor with high heat performance.
- 23.6" x 63" running surface.
- Speed : 1-22 kmph.
- Precise incline control from 0-15%.
- 6LED+dot matrix display showing time, incline, calorie, distance and heart rate.
- Medical grade silicon keys with direct speed (3/6/9) & incline (4/8/12) on the console.
- Various motivating programs for different workout requirements: HRC, custom, manual, hill, fat burn, target, cardio, strength, fit test etc.
- Bluetooth music play.
- Sweat proof console design.
- Large sized, twin cup holder with a built-in tray to hold your mobile phone / tablet.
- Emergency stop button.
- Extra heavy duty running board supporting structure.
- Heavy duty reliable orthopaedic running belt.
- Maximum user weight : 180kg.
- LXWXH : 210×93×161 CM.



X8

COMMERCIAL TREADMILL



SPECIFICATIONS

- AC driving system with adjustable variable frequency.
- 4.0 HP AC continuous (8.0 HP Peak) motor.
- Speed : 1~20 kmph.
- Precise incline control from 0 ~15%.
- 21" x 58" running surface.
- Multi window display showing time, speed, distance, incline, calories & heart rate.
- Direct speed & incline keys on the console.
- Various motivating programs for different workout requirements.
- Double phenolic heavy cushioned deck for excellent shock absorption that provides suitable push off to reduce the possibility of any type of injury to knees and joints.
- Heavy duty reliable orthopedic running belt.
- Emergency stop button.
- Sweat proof console design.
- Two Mobile/Bottle Holders.
- Maximum User Weight : 150 Kgs.
- LXWXH : 216X92X151 CM.



Q3

LIGHT COMMERCIAL TREADMILL



SPECIFICATIONS

- AC driving system with adjustable variable frequency.
- 3.0HP AC continuous (6.0HP Peak) external roto motor with high hear performance.
- 22.44" x 59" running surface.
- Speed:1-20km/h.
- Precise incline control from 0-15%.
- 5 LED+dot matrix display showing time, incline, speed, calorie, distance, heart rate and step.
- Medical grade silicon keys with direct speed (3/6/9) & incline(4/8/12) on the console.
- Various motivating programs for different workout requirements: 4HRC, 18 preset, 1 manual, 1 fit test.
- Sweat proof console design.
- Large sized, twin cup holder with a built in tray to hold your mobile phone & tablet PC.
- Emergency stop button.
- Extra heavy duty running board supporting structure.
- Durable Japanese bearing used in roller.
- Max user weight: 150 kg.
- LXWXH: 197×93×145 cm.



T6262

CURVEMILL



SPECIFICATIONS

- Innovative curved deck with durable nylon belt.
- Non motorized technology.
- Display showing : distance, time, speed, pulse, calories & body fat.
- Exercise description : run, power walk, lateral shuffle & low push.
- With 6 resistance levels.
- Highly durable treadmill with low maintenance cost.
- Ideal for core strength & interval training.
- Long hand rails for maximum safety.
- Maximum user weight 150 kg.
- LXWXH : 200X90X153 CM.



MANUAL

LCD

T007

INCLINE TRAINER



SPECIFICATIONS

- Unique patented Decline to Incline running deck -0.5 ~ 40%.
- Ideal for special training of army, professional sports etc.
- AC driving system with adjustable variable frequency.
- 3.0 HP AC continuous (6.0 HP Peak) motor.
- Speed : 1~20 kmph.
- 21.5" x 61" running surface.
- 7" large window LED display showing time, speed, distance, incline, calories, heart rate etc.
- MP3 connectivity with speakers.
- Various motivating programs for different workout requirements.
- High speed O² generator.
- Heavy duty reliable orthopedic running belt.
- Emergency stop button.
- Sweat proof console design.
- Two Mobile/Bottle Holders.
- Maximum User Weight : 150 Kgs.
- LXWXH : 179X112X202 CM



KH6050

FULL BODY TRAINER



SPECIFICATIONS

- New patented technology that offers user to choose between Climbing/Elliptical/Running/Bike stride
- LED dot matrix showing time, speed, distance, calories, RPM, pulse, watt & resistance
- Various motivating programs for different workout requirements
- Multi grip handle bar
- Variable stride length from 28" to 38" accommodating users of different heights
- Large pedals with toe caps for extra comfort
- Resistance Level : 0-16
- Reinforced frame for extra strength
- The large drink & accessories shelf is conveniently located with easy access while working out
- Maximum User Weight : 180 kgs
- LXWXH : 203X108X174 CM.



E1000

COMMERCIAL ELLIPTICAL TRAINER



SPECIFICATIONS

- Resistance : Magnetron resistance system.
- Power : Self-generation.
- Display : 4 window LED with easy to use control panel.
- Resistance level : 40 levels.
- Program : Constant Watt, Interval, Fat burn, Cardio etc.
- Flywheel : 14kg.
- Maximum User Weight : 180 kgs.
- LXWXH : 176X92X116 CM.



E5555

Signature Series

COMMERCIAL ELLIPTICAL TRAINER



Intuitive LED console display with multi programs.



Ergonomic multi-grip handles with heart rate and colored resistance control keys.



Stainless steel platform for easy entry and exit.

SPECIFICATIONS

- New patented technology with 21" stride.
- 6 window LED display with dot matrix showing time, speed, distance, calories, pace, heart rate etc.
- Offers various motivating programs for different workout requirements.
- Ergonomic multi position dual action handle bars.
- Large and impact-absorbing pedals (**with cushioned gel pads**) provide gentle movement to reduce lower back stress.
- Power: Self Generator.
- Low maintenance and space-saving design.
- Resistance level : 20
- With USB charger.
- Handle bar control.
- Large sized, twin cup holder with a built in tray to hold your ipad, mobile phone or magazine
- Maximum user weight: 180 kg.
- LXWXH : 191X87X180 CM

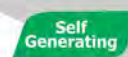

KH3060

COMMERCIAL ELLIPTICAL TRAINER



SPECIFICATIONS

DRIVE

- Rear-drive and handle arms enable sustain, smooth and engaging exercise, regardless your fitness level.
- Ergonomic multi position dual action handle bars.
- Large and impact-absorbing pedals (with cushioned gel pads) provide gentle movement to reduce lower back stress.
- Self-powered system, low maintenance design and space-saving deliver a fast return of investment.
- Power : Generator.
- Resistance level : 20

MONITOR

- Heart rate control programs provide user a challenging training.
- Multi readout summarizes workout result every minute, displays time used, distance covered, burned calories, watt and mets achieved.
- Reliable sweat-proof construction keeps console in demanding commercial environment.

SPECIAL FEATURES

- Offers various motivating programs for different workout requirements.
- Large LED's and intuitive keystroke permit easy-to-operation interface for change and monitor.
- Quick start key allows commencing exercise with a touch of button.
- Display function is switchable for feedback of Level, Watt, Mets and Pulse.
- Cup holder with towel handle.
- Maximum user weight : 180 kg.
- LXWXH : 218X74X161 CM.



E700i

COMMERCIAL ELLIPTICAL TRAINER



SPECIFICATIONS

- Display : 15.6" TFT touch screen.
- Supports Wi-Fi connection & web browsing.
- Resistance level : 40 levels.
- Program : 12 Preset, Manual, Interval, Weight loss, Target heart rate, Random, Warm up & down.
- 10kg two ways flywheel with 22" stride length & 3 pcs crank arm.
- Comes with Earphone port, Speakers & Mobile phone holder.
- Maximum User Weight : 160 kgs.
- LXWXH : 165X53X80 CM.



KH2055

COMMERCIAL ELLIPTICAL TRAINER



SPECIFICATIONS

DRIVE

- Front-drive and handle arms enable sustain, smooth and engaging exercise, regardless your fitness level.
- Large and impact-absorbing pedals provide gentle movement to reduce lower back stress.
- Self-powered system, low maintenance design and space-saving deliver a fast return of investment.
- Striding distance : 500 mm (20").
- Power : Generator.
- Resistance level : 16.

MONITOR

- Heart rate control programs provide user a challenging training.
- Multi readout summarizes workout result every minute, displays time used, distance covered, burned calories, watt and mets achieved.
- Reliable sweat-proof construction keeps console in demanding commercial environment.

SPECIAL FEATURES

- Offers 4 programs and upto 16 resistance levels to keep fitness routine effective and fresh.
- Large LED's and intuitive keystroke permit easy to operate interface for change and monitor.
- Quick start key allows commencing exercise with a touch of button.
- Display function is switchable for feedback of Level, Watt, Mets and Pulse.
- Maximum user weight : 150 kg.
- LXWXH : 206X80X176 CM.



KH2050

COMMERCIAL ELLIPTICAL TRAINER



SPECIFICATIONS

DRIVE

- Rear-drive and handle arms enable sustain, smooth and engaging exercise, regardless your fitness level.
- Large and impact-absorbing pedals provide gentle movement to reduce lower back stress.
- Self- powered system, low maintenance design and space-saving deliver a fast return of investment.
- Striding distance : 500 mm (20").
- Power : Generator.
- Resistance level : 16.

MONITOR

- Heart rate control programs provide user a challenging training.
- Multi readout summarizes workout result every minute, displays time used, distance covered, burned calories, watt and mets achieved.
- Reliable sweat-proof construction keeps console in demanding commercial environment.

SPECIAL FEATURES

- Offers 6 programs and upto 16 resistance levels to keep fitness routine effective and fresh.
- Large LED's and intuitive keystroke permit easy-to-operation interface for change and monitor.
- Quick start key allows commencing exercise with a touch of button.
- Display function is switchable for feedback of Level, Watt, Mets and Pulse.
- Maximum user weight : 150 kg.
- LXWXH : 196X72X146 CM.



E600

COMMERCIAL ELLIPTICAL TRAINER



SPECIFICATIONS

- LED dot matrix console readouts: INCLINE, TIME, DISTANCE, CALORIES, PULSE, SPEED / RPM, LEVEL, WATT, FAN etc.
- Various motivating programs for different workout requirements.
- Level Control : 20 resistance levels.
- With 15 level power incline.
- 500mm x 220mm unique stride length.
- 12 kgs flywheel.
- Both forward & reverse motions offer various workout options.
- Hand held pulse sensors enable to monitor the heart rate all times.
- Mp3 with speaker and USB charger.
- With O2 generator and bottle holder.
- Unique durable floor levelers on front & rear stabilizer.
- With adaptor power system.
- Maximum user weight : 150 kg
- LXWXH : 215X77X194 CM.



E900

COMMERCIAL ELLIPTICAL TRAINER



SPECIFICATIONS

- Resistance : Magneton resistance system.
- Display : 5 window LED dot matrix.
- Self power generating.
- Resistance level : 32 levels.
- Various motivating programs for different workout requirements.
- 14.2kg two ways flywheel with 20" stride length & 3 pcs crank arm.
- Comes with Mobile phone holder & Transport wheels.
- Maximum User Weight : 160 kgs.
- LXWXH : 190X85X176 CM.

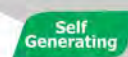

E700

COMMERCIAL ELLIPTICAL TRAINER



SPECIFICATIONS

- Display : 5 window LED dot matrix.
- Self power generating.
- Resistance level : 40 levels.
- Program : 12 Preset, Manual, Interval, Weight loss, Target heart rate, Random, Warm up & down.
- 14.2kg two ways flywheel with 22" stride length & 3 pcs crank arm.
- Comes with Mobile phone holder & Transport wheels.
- Maximum User Weight : 160 kgs.
- LXWXH : 165X53X80 CM.



E800

COMMERCIAL ELLIPTICAL TRAINER



SPECIFICATIONS

- Rear drive and dual handle arms enable smooth and engaging exercise, regardless of your fitness level.
- Self-powered system.
- LED screen.
- 8 Defaulted programs + 2 customized programs.
- Stride distance : 500mm.
- Resistance level : 26 levels.
- Max user weight : 150KGS.
- LXWXH : 209X78X168 cm.



KH2070

COMMERCIAL ELLIPTICAL TRAINER



SPECIFICATIONS

- Rear-drive and dual handle arms enable smooth and engaging exercise, regardless of your fitness level.
- Large and impact-absorbing pedals provide gentle movement to reduce lower back stress.
- Self- powered system, low maintenance and space-saving design.
- Multi LED Dot matrix display.
- Various motivating programs for different workout requirements.
- Striding distance : 500 mm (20").
- Power: Generator.
- Resistance level : 15.
- Maximum user weight: 150 kg.
- LXWXH : 218x75x178 cm.



KH620

COMMERCIAL ELLIPTICAL TRAINER



SPECIFICATIONS

- 20" long stride.
 - Red backlight LED display.
 - Readouts: Time, speed, distance, calories, pulse, watt, program, bodyfat (height/weight/age) and level.
 - Multiple programs including 1 Manual, 4 HRC, 1 Watt, 20 preset, 4 Users and 3 Fitness test.
 - 3 pcs crank system with 14kgs flywheels.
 - USB port with MP3 reader.
 - Handheld pulse sensor.
 - Magnetic flywheel.
 - With self generating system.
 - Resistance level - 24.
 - Transport wheels.
 - Adjustable floor levelers.
- Maximum User Weight: 150kgs.



E200

COMMERCIAL ELLIPTICAL TRAINER



SPECIFICATIONS

- LED dot matrix console readouts: TIME, DISTANCE, CALORIES, PULSE, SPEED / RPM, LEVEL, WATT, FAN etc.
- Various motivating programs for different workout requirements.
- Level Control : 24 resistance levels.
- Dual Technology - resistance with both magnetic and air.
- 520mm x 240mm unique stride length.
- 8 kgs flywheel.
- Both forward & reverse motions offer various workout options.
- Hand held pulse sensors enable to monitor the heart rate all times.
- With ipad holder & bottle cage.
- Unique durable floor levelers on front & rear stabilizer.
- Transport wheels on the front stabilizer, providing easy movement to move the items.
- With adaptor power system.
- Maximum user weight : 150 kg.
- LXWXH : 162X65X180 CM.



KH640

COMMERCIAL ELLIPTICAL TRAINER



SPECIFICATIONS

- Display : 5 window LED dot matrix.
- Self power generating.
- Resistance level : 40 levels.
- Program : 12 Preset, Manual, Interval, Weight loss, Target heart rate, Random, Warm up & down.
- 14.2kg two ways flywheel with 19" stride length & 3 pcs crank arm.
- Comes with Mobile phone holder & Transport wheels.
- Maximum User Weight : 160 kgs.
- LXWXH : 200X81X166 CM.



KH585

COMMERCIAL ELLIPTICAL TRAINER



SPECIFICATIONS

Drive

- Rear Drive and handle arms enable sustain, smooth and engaging exercise, regardless your fitness level.
- Ergonomic multi position dual action handle bars.
- Large & impact-absorbing pedals (with gel pads) provide gentle movement to reduce lower back stress.
- Self-powered system, low maintenance design & space-saving deliver a fast return of investment.
- Power : Generator.
- Resistance level : 32.

Monitor

- Heart rate control programs provide user a challenging training.
- Multi readout summarizes workout result every minute, displays time used, distance covered, burned calories, watt and meters achieved.

Special Features

- Offers various motivating programs for different workout requirements.
- Large LED's and intuitive keystroke permit easy to operate interface for change and monitor.
- Quick start key allows commencing exercise with a touch of a button.
- Display function is switchable for feedback of Level, Watt, Meters and Pulse.
- Cup holder with towel handle.
- Max User Weight :150Kgs.
- LxWxH : 210x64x180 cm.



KH595

LIGHT COMMERCIAL ELLIPTICAL TRAINER



SPECIFICATIONS

- Front Drive with long handle arms enabling smooth and engaging exercise regardless your fitness level.
- With 3 level manual incline.
- 20" Long stride length for different user heights.
- Auto scan advanced computer with blue back-lit screen.
- Display Readouts : time, distance, RPM, speed, level, calories, pulse & watts.
- Magnetic brake with V-belt drive system.
- With 7 kg flywheel.
- With 3 pcs hidden crank system.
- 16 levels tension control system.
- Multiple programs, including 1 manual, 2 HRC, 1 body fat & 2 user set.
- Hand held pulse sensor.
- With adapter power system.
- Transport wheels.
- Adjustable floor levelers.
- Maximum user weight : 130kgs.
- LXWXH : 173X66X170 CM.

KH610

LIGHT COMMERCIAL ELLIPTICAL TRAINER



SPECIFICATIONS

- 20" long stride.
- 3 section manual incline.
- Blue backlight LCD display.
- Readouts: Time, speed, distance, calories, pulse, watt, program, bodyfat (height/weight/age) and level.
- Multiple programs including 1 Manual, 4 HRC, 1 Watt,
- 11 preset, 4 Users and 3 Fitness test.
- Handheld pulse sensor.
- Magnetic flywheel.
- With adapter power system.
- Resistance level - 24.
- Transport wheels.
- Adjustable floor levelers.
- Maximum User Weight: 130kgs.
- LXWXH : 176X68X179 CM

KH580

LIGHT COMMERCIAL ELLIPTICAL TRAINER



SPECIFICATIONS

- 18" long stride.
- Adjustable swing bar.
- LCD display readouts : Time, Distance, RPM, Speed, Calories, Pulse and Watts.
- Multiple programs including 1 Manual, 4 HRC, 3 Goal and 5 Users.
- Handheld pulse sensor.
- 30 cm fly wheel.
- Motor magnetic 24 level resistance.
- With adaptor power system.
- Transport wheels.
- Adjustable floor levelers.
- Maximum User Weight : 130 Kgs.
- LXWXH : 165X60X163 CM.

KH690

LIGHT COMMERCIAL ELLIPTICAL TRAINER



SPECIFICATIONS

Drive

- Pull Motor System with poly V-belt.
- Resistance system : New Technology silent programmable magnetic resistance system.
- Resistance level : 32 levels.
- With adaptor power system.

Monitor

- Advance LCD display.
- Display readouts : Time, Distance, Speed, Level, Calories, Pulse & Watts.
- 10 programs.

Special Features

- With 4 level manual incline.
- Adjustable stride for ultimate workout.
- Both forward and reverse motions offer various workout options.
- Heavy -gauge, epoxy hybrid, steel frame.
- Low impact workout.
- Long stride & 9 kg of rotating flywheel ensures smooth & dynamic elliptical movement.
- Comfy over-sized, non-slip pedals.
- Handheld pulse sensors.
- Dual action handle bars with high density foam grips.
- Accessory tray & built-in reading rack.
- Transport wheels.
- Swift support.
- Bluetooth support.
- Adjustable floor levelers.
- Maximum User Weight : 150 Kgs.
- LXWXH : 165X63X170 CM.

KH965

LIGHT COMMERCIAL ELLIPTICAL TRAINER



SPECIFICATIONS

- 20" long stride length with 2 levels of adjustment.
- Adjustable swing bar.
- Display readouts : Time, Distance, RPM, Speed, Calories, Pulse, Body Ratio, BMI, BMR and Temperature.
- Various motivating programs for different workout requirements.
- Handheld pulse sensor.
- 10kgs flywheel.
- 15 level Magnetic resistance system.
- Transport wheels.
- Adjustable floor levelers.
- Maximum User Weight : 135 Kgs.

KH960

LIGHT COMMERCIAL ELLIPTICAL TRAINER



SPECIFICATIONS

- 20" long stride length with 2 levels of adjustment.
- Adjustable swing bar.
- Display readouts : Time, Distance, RPM, Speed, Calories, Pulse, Body ratio, BMI, BMR and Temperature.
- Handheld pulse sensor.
- 10 kgs fly wheel.
- Magnetic 8 level manual tension control system.
- Transport wheels.
- Adjustable floor levelers.
- Maximum User Weight : 130 Kgs.

R5555

Signature Series

COMMERCIAL RECUMBENT BIKE



Oversize intuitive LED console display with multi programs.



Ergonomic multi-grip handles with heart rate and colored resistance control keys.



Contoured and ventilated mesh seat back for improved comfort and enhanced air flow.

SPECIFICATIONS

- 6 window LED display with dot matrix showing time, speed, distance, calories, pace, heart rate etc.
- Offers various motivating programs for different workout requirements.
- Ergonomic multi grip handles with heart rate & resistance control keys.
- Weighted pedals provide gentle movement to reduce lower back stress.
- Power: Self Generator.
- Low maintenance and space-saving design.
- Resistance level : 20
- 8 kg flywheel weight
- With USB charger.
- Large sized, twin cup holder with a built in tray to hold your ipad, mobile phone or magazine
- Maximum user weight: 180 kg.
- LXWXH : 168X64X150 CM.



KH3040

COMMERCIAL RECUMBENT BIKE



SPECIFICATIONS

DRIVE

- Two stage drive with poly V-belt.
- Resistance System : Self powered hybrid brake.
- Resistance Level : 20 Levels.

MONITOR

- 7 window dot matrix LED display.
- Display readouts : Time, Distance, RPM, Speed, Level, Calories, Pulse and Watts.
- Various motivating programs for different workout requirements.

SPECIAL FEATURES

- The easy-to-operate adjustment bar to move the seat forward and backward.
- Walk-through design to get on / off easily.
- Accessory tray with cup holder.
- Seat handle bars with quick access resistance (+/-) keys and handheld pulse sensors.
- Adjustable pedal straps
- Aluminum upright beam
- Hidden 3 piece cranks inside crank cover for safety
- Transport wheels
- Adjustable floor levelers
- Built-in receiver
- Maximum User Weight : 180 kgs
- LXWXH : 165X64X138 CM.



KH1140

COMMERCIAL RECUMBENT BIKE



SPECIFICATIONS

- Dot matrix LED display showing Pulse, Recovery, Time, RPM, Speed, Distance, Calories, Watt, Heart Rate & Resistance.
- With self generator system.
- 12 programs : 4 HRC, 3 goal, 1 recovery and 4 user.
- Magnetic brake with V-belt drive system.
- 16 levels tension control system.
- Ergonomic seat adjustment.
- With heart rate receiver.
- Hand grips with pulse sensor.
- Counter balance pedals.
- With bottle holder.
- Adjustable PU seat.
- Transport wheels.
- Maximum user weight: 150 kgs.
- LXWXH : 176X59X126 CM.



KH619

COMMERCIAL RECUMBENT BIKE



SPECIFICATIONS

Drive

- One stage drive with poly V-belt.
- Resistance System : Self powered generator brake.
- Resistance Level : 32 Levels.

Monitor

- LED(red light).
- Display readouts : speed,time,distance,calorie,heart rate,level,wat.
- 20 programs : 1 manual, 11 presetting , 4 HRC , 3 fittest, 1 wat.

Special Features

- The easy-to-operate adjustment to move the seat forward and backward.
- Walk-through design to get on / off easily.
- Seat handle bars with handheld pulse sensors.
- Adjustable pedal straps.
- 3 piece crank.
- Built-in speakers & Bluetooth Music.
- With IP support bracket.
- Transport wheels.
- Adjustable floor levelers.
- Maximum User Weight: 180 kgs.



KH575

COMMERCIAL RECUMBENT BIKE



SPECIFICATIONS

Drive

- Two stage drive with poly V-belt.
- Resistance System : Self powered hybrid brake
- Resistance Level : 32 Levels

Monitor

- 7 window dot matrix LED display
- Display readouts : Time, Distance, Speed, Level, Calories, Pulse and Watts
- Various motivating programs for different workout requirements

Special Features

- The easy-to-operate adjustment bar to move the seat forward and backward
- Walk-through design to get on / off easily
- Adjustable resistance levels
- Aluminum upright beam
- Hidden 3 piece cranks inside crank cover for safety
- Transport wheels
- With easy moving wheels
- Built-in receiver
- Maximum User Weight: 150 kgs
- LxWxH : 183x68x90 cms



KH820

LIGHT COMMERCIAL RECUMBENT BIKE



SPECIFICATIONS

- Auto scan advanced computer with blue BACK-LT LCD screen.
- 12 programs, including 1 manual, 2 HRC, 1 body fat, 2 user set.
- Display showing Pulse, Recovery, Time, RPM/Speed, Distance, K joule or Calories, Watt/Target Heart rate, Fat%, BMI, BMR, Body Type.
- Magnetic brake with V-belt drive system.
- 16 levels tension control system.
- With adapter power system.
- Innovative adjustment end cap, easy to go with uneven floor.
- Aluminum upright & seat rails.
- PU seat & back rest.
- Easy to adjust seat position.
- Hand grip pulse sensors.
- Hidden crank(3pcs) safer & neat.
- Transport wheels.
- Maximum user weight: 130 kg



U5555

Signature Series

COMMERCIAL UPRIGHT BIKE



Oversize intuitive LED console display with multi programs.



Ergonomic multi-grip handles with heart rate and colored resistance control keys.



Ergonomic single-hand seat adjustment makes easy to find the right position.

SPECIFICATIONS

- 6 window LED display with dot matrix showing time, speed, distance, calories, pace, heart rate etc.
- Offers various motivating programs for different workout requirements.
- Ergonomic multi grip handles with heart rate & resistance control keys.
- Weighted pedals provide gentle movement to reduce lower back stress.
- Power: Self Generator.
- Low maintenance and space-saving design.
- Resistance level : 20
- 8 kg flywheel weight
- With USB charger.
- Large sized, twin cup holder with a built in tray to hold your ipad, mobile phone or magazine
- Maximum user weight: 180 kg.
- LXWXH : 105X73X149 CM.



KH3020

COMMERCIAL UPRIGHT BIKE



SPECIFICATIONS

DRIVE

- Two stage drive with poly V-belt.
- Resistance System : Self powered hybrid brake.
- Resistance Level : 20 Levels.

MONITOR

- 7 window dot matrix LED display.
- Display readouts : Time, Distance, RPM, Speed, Level, Calories, Pulse and Watts .
- Various motivating programs for different workout requirements.

SPECIAL FEATURES

- Various seat height level adjustments.
- Accessory tray with cup holder.
- Adjustable pedal straps.
- Aluminum upright beam.
- Hidden 3 piece cranks inside crank cover for safety.
- Transport wheels.
- Adjustable floor levelers.
- Built-in receiver.
- Maximum User Weight : 180 kgs.
- LXWXH : 109X60X149 CM.



KH2025

COMMERCIAL UPRIGHT BIKE

SPECIFICATIONS

DRIVE

- One stage drive with poly V-belt.
- Resistance System : Self powered generator brake.
- Resistance Level : 36 Levels.

MONITOR

- Advanced computer with 7" LCD blue Back-Lit screen.
- Display readouts : Time, Distance, RPM, Speed, Level, Calories, Pulse and Watts.
- 14 Programs, including 10 Manual, 2 HRC, 2 User set.

SPECIAL FEATURES

- Various seat height levels easily adjusted by knob ball while being seated.
- Ergonomic stationary handle bars with adjustable arm pads.
- Handheld pulse sensor.
- Adjustable pedal straps.
- 3 piece cranks.
- Transport wheels
- Built-in speakers & Ipad / MP3 auxillary jack.
- Ipad / Ipod charging station.
- High speed circulation fan that allows the user to stay cool during workout.
- Accessory tray, built-in reading rack.
- Adjustable floor levelers.
- Built-in receiver.
- Maximun User Weight : 180 Kgs.
- LXWXH : 123X65X144 CM.



KH1120

COMMERCIAL UPRIGHT BIKE

SPECIFICATIONS

- Dot matrix LED display showing Pulse, Recovery, Time, RPM, Speed, Distance, Calories, Watt, Heart Rate and Resistance.
- With self generator system.
- 12 programs : 4 HRC, 3 goal, 1 recovery and 4 user.
- Magnetic brake with V-belt drive system.
- 16 levels tension control system.
- With heart rate receiver.
- Hand grips with pulse sensors.
- Counter balance pedals.
- With bottle holder.
- PU seat with adjustable height.
- Transport wheels.
- Maximum User Weight : 150 kg.
- LXWXH : 129X56X156 CM.



KH1020

COMMERCIAL UPRIGHT BIKE

SPECIFICATIONS

- LED display showing Pulse, Recovery, Time, RPM, Speed, Distance, Calories, Watt, Heart Rate and Resistance.
- With self generator system.
- 12 programs : 4 HRC, 3 goal, 1 recovery and 4 user.
- Magnetic brake with V-belt drive system.
- 16 levels tension control system.
- With heart rate receiver.
- Hand grips with pulse sensors.
- Counter balance pedals.
- With bottle holder.
- PU seat with adjustable height.
- Transport wheels.
- Maximum User Weight : 140 Kgs.
- LXWXH : 105X56X152 CM.



KH618

COMMERCIAL UPRIGHT BIKE

SPECIFICATIONS

Drive

- One stage drive with poly V-belt
- Resistance System : Self powered generator brake.
- Resistance Level : 32 Levels

Monitor

- LED (red light)
- Display readouts : speed, time, distance, calorie, heart rate, level, wat.
- 20 programs : 1 manual , 11 presetting, 4 HRC , 3 fittest, 1 wat.

Special Features

- Various seat height levels easily adjustable by knob ball
- Ergonomic stationary handle bars
- Handheld pulse sensor
- Adjustable pedal straps
- 3 piece cranks
- Transport wheels
- Built-in speakers & Bluetooth Music
- With IP support bracket
- Adjustable floor levelers
- Maximum User Weight: 180 kgs



KH565

COMMERCIAL UPRIGHT BIKE

SPECIFICATIONS

Drive

- Two stage drive with poly V-belt.
- Resistance System : Self powered
- Resistance Level : 32 Levels

Monitor

- 7 window dot matrix LED display
- Display readouts : Time, Distance, Speed, Level, Calories, Pulse and Watts
- Various motivating programs for different workout requirements

Special Features

- The easy-to-operate seat for up and down position
- Walk-through design to get on / off easily
- Accessory tray with cup holder
- Adjustable resistance levels
- Aluminum upright beam
- Hidden 3 piece cranks inside crank cover for safety
- Transport wheels
- With easy moving wheels
- Built-in receiver
- Maximum User Weight: 150 kgs
- LxWxH : 111x56x148 cms



KH815

LIGHT COMMERCIAL UPRIGHT BIKE

SPECIFICATIONS

- Auto scan advanced computer with blue BACK-LT LCD screen.
- 12 programs, including 1 manual, 2 HRC, 1 body fat, 2 user set.
- Display showing Pulse, Recovery, Time, RPM/Speed, Distance, K joule or Calories, Watt/Target Heart rate, Fat%, BMI, BMR, Body Type.
- Magnetic brake with V-belt drive system.
- 16 levels tension control system.
- With adapter power system.
- Innovative adjustment end cap, easy to go with uneven floor.
- Aluminum upright beam.
- Hand grip pulse sensors.
- Counter balance pedals.
- PU seat, seat height is adjustable.
- Hidden crank(3pcs) safer & neat.
- Transport wheels.
- Maximum user weight: 130 kg.



AB1000

COMMERCIAL AIR BIKE

The resistance is delivered by fan, which is driven by power and speed pedal along with two handles that move back and forth. Users are able to determine intensity level and resistance.



26 ABS blades molded into one piece which makes it more stable and quiet than traditional steel blades in using condition.



The workout data can be synchronized to your smart devices via Bluetooth or ANT+. Then you can track the data with 3rd party applications which manage your training more scientific. It helps users to make a more reasonable training plan.



Consider electroplated steel gets rust easily, the seat support and pedals of AIR BIKE are made of aluminum alloy, which is less prone to corrosion, helping to provide long service life.



Compared to ordinary, AIR BIKE with its chain always sways and bumps and needs scheduled maintenance. AIR BIKE's V-Belt drive provides smooth and consistent ride without extra maintenance or high cost.



Maximum User Weight	150kg	Programs	3 target programs (Time, Distance, Calories), 3 Heart Rate Programs (65%, 75%, 85%), 4 Interval Programs (3 time interval and 1 distance interval)
Resistance	Air Resistance	Heart Rate Monitor	Telemetry (Compatible with Polar heart rate belt)
Drive Model	Belt Drive	Cup Holder	Yes
Pedals & handle bars	Synchronized Motion	Fan Size	26 inches
Pedals	Double Faced Aluminum Alloy	Fan Blades	26 ABS Curved blades
Footholds	Aluminum	Product Dimension	130 × 71 × 134 CM
Crank	Oversize		
Console Display	5" LCD Screen		
Console Readouts	Time, Speed/Average Speed, Calories/Average Calories, Distance, RPM/Average RPM, Watt/Average Watt, Heart Rate/ Average Heart Rate		

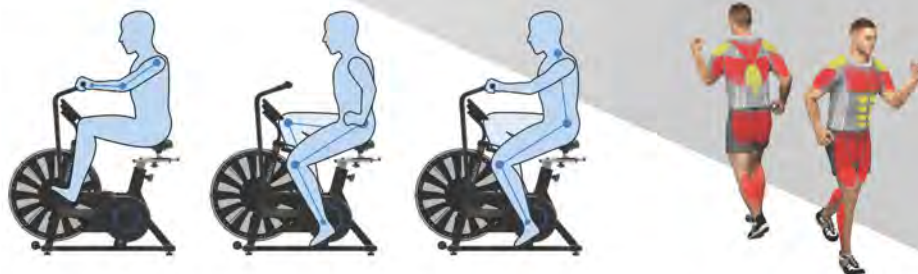

This Bike enables users to do upper body training, lower body training and total body training. It helps to improve your body coordination and meets training demands of various people.

AB400

COMMERCIAL AIR BIKE

SPECIFICATIONS

- System : Fan drive
- 1 manual + 12 built-in programs
- Built-in wireless receiver
- Transport wheels + Aluminium pedals
- Big LCD screen with backlit
- Quick buttons for interval program
- Maximum use r weight: 150 kg.
- LxWxH : 129x59x122 cms



KH3010

COMMERCIAL GROUP BIKE

SPECIFICATIONS

- Ultra sturdy structure with heavy duty crank.
- 21 kgs stainless steel fly wheel.
- Fully adjustable GEL seat with sweat proof finish.
- 4 way adjustable handle bar.
- Resistance Levels : Variable linear increase.
- Side break system.
- SPD racing pedals.
- Transport wheels for easy movement.
- Maximum user weight : 180 kg.
- LXWXH : 119X53X105 CM.



KH156

COMMERCIAL GROUP BIKE

- SPECIFICATIONS**
- Comes with large computer display
 - Adjustable resistance
 - Racing handle bar
 - With 20kgs flywheel
 - 3 piece aluminum crank with SPD pedals
 - Computer functions : time, speed, distance, calories & pulse
 - Maximum User Weight : 150 Kgs
 - LXWXH : 124X51X120 cm



KH1710

COMMERCIAL GROUP BIKE

- SPECIFICATIONS**
- Ultra sturdy PATENTED design.
 - New fully covered design making it sweat proof.
 - Adjustable seat and handle.
 - High quality ribbed belt with tension wheel driving system.
 - Press type braking system.
 - Maximum user weight : 150 kg.
 - LXWXH : 219X96X160 CM.



KH153

COMMERCIAL GROUP BIKE

- SPECIFICATIONS**
- Adjustable resistance.
 - Dipping handle bar.
 - With 20kgs flywheel.
 - With adjustable seat.
 - Computer functions : time, speed, distance, calories & pulse.
 - Maximum User Weight 140 Kgs.
 - LXWXH : 115X50X123 CM.



KH142

COMMERCIAL GROUP BIKE

- SPECIFICATIONS**
- Ultra sturdy with heavy duty crank.
 - Fully adjustable Gel seat with sweat proof finish.
 - With 18 kg flywheel.
 - Adjustable handle bar with up & down position.
 - High quality ribbed belt with tension wheel driving system.
 - Press type braking system.
 - Rust proof aluminum seat and handle tube.
 - Maximum user weight : 150 kg.
 - LXWXH : 107X58X112 CM.



AR1000

COMMERCIAL AIR ROWER



Drive Model	Chain
Maximum User Weight	150kg
Resistance Design	Air Resistance
Console Display	5" LCD display with 8 readout windows
Console Readouts	Time, Stroke Rate, Pace, Distance, Watts, Calories, Heart Rate, Level
Programs	Multiple
HR Monitor	Telemetry
Product Dimension	224 × 36 × 106 CM

SR1000

COMMERCIAL SKI / AIR ROWER

Maximum User Weight	150kg
Drive Model	Belt
Handlebar Design	Rowing Bar & Skiing Bar
Flywheel Weight	4.1kg
Special Features	Provided Rowing & Skiing Training
Resistance Design	MARS (Magnetic & Air Resistance System)
Resistance Power	300W
Resistance Levels	20
Console Display	5" LCD display with 8 readout windows
Console Readouts	Time, Stroke Rate, Pace, Distance, Watts, Calories, Heart Rate, Level
Programs	5 (Time/Distance/Calorie Target, Interval Time/Distance)
HR Monitor	Telemetry
Product Dimension	Horizontal Form: 262 × 88 × 106 CM Vertical Form: 136 × 88 × 214 CM
Seat Height	513mm/ 20.2"
Monorail	1663mm/ 65.5" (Aluminum)

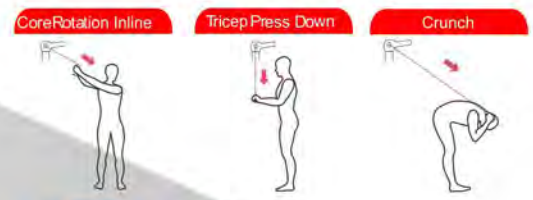
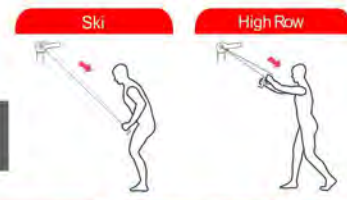

Skiing bar made of TPR materials allows for a comfortable grab feeling.

A folded Ski & Row saves 48% floor space comparing with rower form.

The transport wheels make it easy to place to a workout space.



Folding lock-up system ensures safety in daily using condition.



MARS (Magnetic & Air Resistance System) allows users to control their exertion and resistance at all times. The MARS system comes with 20 settings you can change the resistance to suit your performance.



Heart rate telemetry system helps users to monitor intensity of the workout. Adjustable angles of console provides users with the best viewing experience.

High intensity courts achieve the maximum strength test up to 1,000,000 times ensuring the high quality of product.



Ergonomic seat enables users to train comfortably. Light-weight aluminum and stainless steel made sled rail allows users to train intensively and provide low maintenance.



Adjustable pedals and ergonomic handle bars accommodate different users' need. The sturdy legs provide users a comfortable and stable movement.



The SKI&ROW can be used in standing form, which provides upper body training and core training. Optional foot straps help users to train lower body and complete the workout shown below.

Cable **Rear** **Lateral Raises** **Leg Extension** **Hip Flexion** **Leg Curl** **Hip Abduction**



AR600

COMMERCIAL WATER ROWER

SPECIFICATIONS

- Solid wooden base frame.
- Water generated resistance system.
- High strength belt strap for a smooth and quiet pull.
- Back-lit bright LCD monitor that displays all workout data.
- Compatible with KINOMAP.
- Comes with mobile holder.
- High quality contoured seat.
- Adjustable footrest with numbered setting
- Max. user weight: 160 Kgs.



AR500

COMMERCIAL AIR ROWER

SPECIFICATIONS

- Solid steel frame that folds up for easy storage.
- Air generated 10 levels resistance.
- High strength steel chain rowing strap for a smooth and quiet pull.
- Back-lit bright LCD monitor that displays all workout data.
- Compatible with FITLOG, KINOMAP and ZWIFT.
- High quality contoured seat.
- Adjustable footrest with numbered setting
- Max. user weight: 160 Kgs.
- LXWXH : 241X62X111 CM.



SKI 2

SKI MACHINE

SPECIFICATIONS

- Durable and ergonomic construction.
- Can be either mounted on a wall or with specially designed anti-skid floor stand.
- Air generated 10 levels resistance.
- High strength light weight drive cord with strapless handles for secure grip.
- Back-lit bright LCD monitor that displays all workout data.
- Max. user weight: 160 Kgs.
- LXWXH : 128X62X216 CM.



SKI 500

SKI MACHINE

SPECIFICATIONS

- Durable and ergonomic construction.
- Can be either mounted on a wall or with specially designed anti-skid floor stand.
- Air generated 10 levels resistance.
- High strength light weight drive cord with strapless handles for secure grip.
- Back-lit bright LCD monitor that displays all workout data.
- Compatible with FITLOG, KINOMAP and ZWIFT.
- Max. user weight: 160 Kgs.
- LXWXH : 128X62X216 CM.



INFINITY TRAINER

SPECIFICATIONS

- Unique machine with variety of exercises possible.
- Heavy duty stainless steel base.
- Dimensions : 220x135x162 cms
- Weight : 160 kgs



TYRE FLIP 180

SPECIFICATIONS

- Starting resistance of 100 lbs.
- Plate loaded ability up to 40 additional pounds.
- 4 sound reducing bumpers .
- 2 battle rope anchor points.
- 4 floor levelers.
- 8 floor mounting points.
- Weight of the tyre : 49 kgs.
- Weight of the machine : 145 kgs.
- LXWXH : 164X124X60 CM.



KH6060

STEPMILL

Durable peddle and chain design



Smart quick & program keys



Easy reach handle bar



Powerful 2 HP AC motor drive system



SPECIFICATIONS

- Console : LED dot-matrix display.
- Data readout : Level, calories, time, distance, speed etc.
- Program : Calories goal, marathon, random, hill, speed interval, fat burn, cardio, fitness training 5k / 10k, interval heart rate control, Intensive heart rate & manual.
- With water bottle holder & accessories tray.
- SPM level : 20 levels.
- With USB charging port.
- With O² generator.
- Max user weight : 180 kgs.
- LXWXH : 156X100X214 CM.



KH3030

STEPMILL



Big comfortable paddles

SPECIFICATIONS

- Magnetic EMS system.
- Console : LED dot-matrix display
- Data readout : Speed level, calories, time, distance, steps etc.
- Program : Various motivating programs for different workout requirements.
- With water bottle holder.
- Max user weight : 150 kgs.
- LXWXH : 145X82X208 CM.

A highly muscular Black male bodybuilder is shown in a gym, performing a lat pulldown exercise. He has a very large, thick braid that runs down the center of his chest. He is wearing black briefs and is pulling down on a metal handle attached to a cable. His muscles are extremely defined and glistening. The background shows gym equipment and a sign that says "ARMS".

VIVA[®]
FITNESS

PushYourself

SIGNATURE SERIES UNIQUE FEATURES

Integrated weight stack tower that offers both safety environmental protection

304 stainless steel rotating shaft which is strong, durable and beautiful

PU moulded foam cushions - Environmentally friendly, comfortable and durable

High quality ϕ 4.8mm cable - smooth operation, high strength and long life

Select pin is made of 6063 aluminum for smooth, durable and noiseless movement. Surface oxidation red treatment

Stainless steel adjusting plate



PC2101

MULTI PRESS

- LXWXH : 198X135X166 CM.
- Weight stack : 150 LBS.

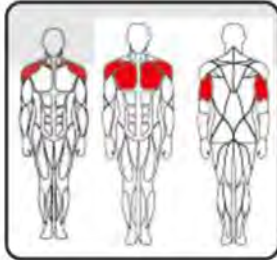

PC2102

LAT PULL / SEATED ROW

- LXWXH : 188X121X225 CM.
- Weight stack : 190 LBS.

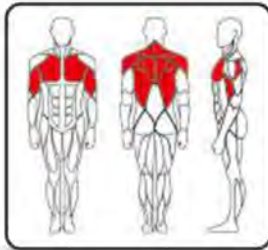

PC2103

PEC FLY / REAR DELT

- LXWXH : 137X150X195 CM.
- Weight stack : 220 LBS.

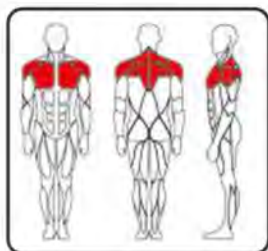

PC2104

DIP / CHIN ASSIST

- LXWXH : 116X154X220 CM.
- Weight stack : 170 LBS.

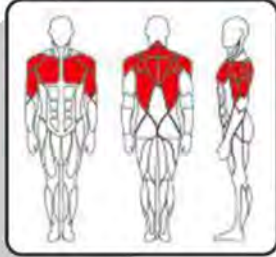

PC2105

LEG EXTENSION / LEG CURL

- LXWXH : 161X133X158 CM.
- Weight stack : 220 LBS.

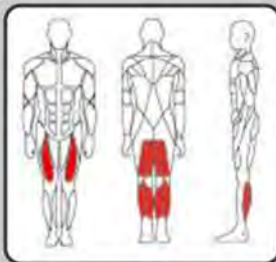

PC2106

HIP ABDUCTOR / ADDUCTOR

- LXWXH : 167X73X158 CM.
- Weight stack : 150 LBS.

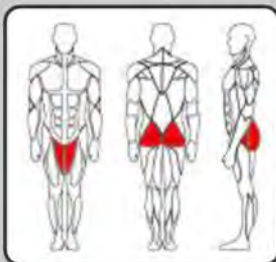

PC2107

BICEP CURL / TRICEPS EXTENSION

- LXWXH : 124X131X158 CM.
- Weight stack : 220 LBS.



PC2108

LEG PRESS / CALF EXTENSION

- LXWXH : 194X114X158 CM.
- Weight stack : 290 LBS.

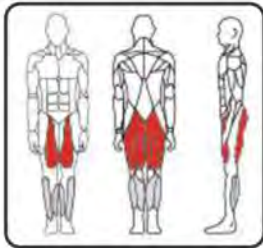

PC2109

ABDOMINAL / BACK EXTENSION

- LXWXH : 131X121X158 CM.
- Weight stack : 200 LBS.

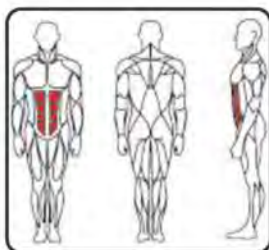

PC2110

DEEP SQUAT / STANDING CALF EXTENSION

- LXWXH : 130X115X158 CM.
- Weight stack : 220 LBS.

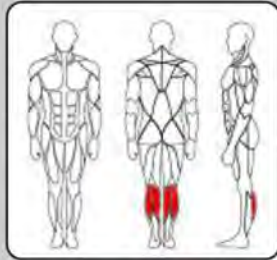

PC2111

ROTARY HIP

- LXWXH : 148X93X158 CM.
- Weight stack : 150 LBS.

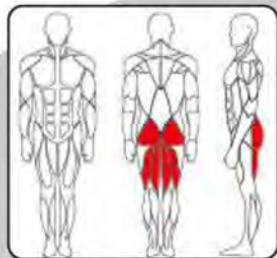

PC2122

LAT PULLDOWN

- LXWXH : 167X143X202 CM.
- Weight stack : 300 LBS.

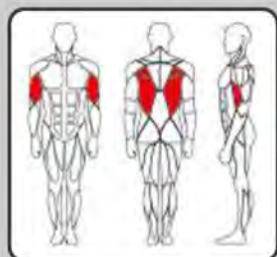

PC2201

CHEST PRESS

- LXWXH : 97X152X182 CM.
- Weight stack : 240 LBS.



PC2202

SEATED ROW

- LXWXH : 159X108X150 CM.
- Weight stack : 230 LBS.

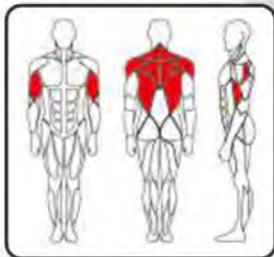

PC2203

SHOULDER PRESS

- LXWXH : 171X146X150 CM.
- Weight stack : 240 LBS.

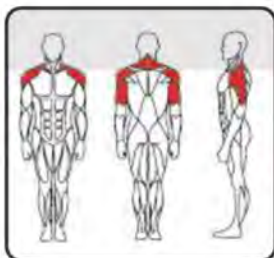

PC2204

TORSO ROTATION

- LXWXH : 86X126X150CM.
- Weight stack : 120 LBS.

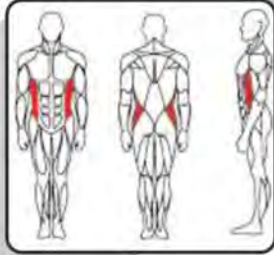

PC2205

LEG EXTENSION

- LXWXH : 127X121X150 CM.
- Weight stack : 230 LBS.

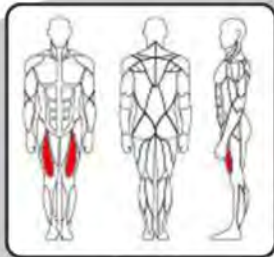

PC2206

SEATED LEG CURL

- LXWXH : 143X121X150 CM.
- Weight stack : 230 LBS.

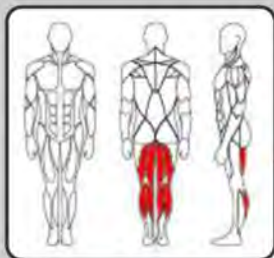

PC2211

SEATED LEG PRESS

- LXWXH : 186X114X150 CM.
- Weight stack : 330 LBS.

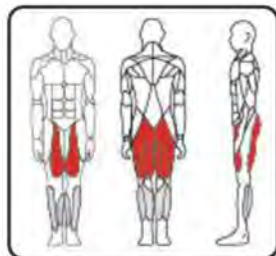

PC2212

DELTOID TRAINER

- LXWXH : 150X88X157 CM.
- Weight stack : 120 LBS.

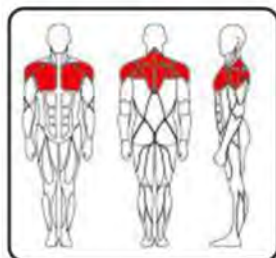

PC2215

HIP TRAINER

- LXWXH : 163X113X150 CM.
- Weight stack : 150 LBS.

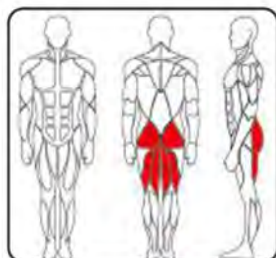

PC2218

PRONE LEG CURL

- LXWXH : 173X124X150 CM.
- Weight stack : 230 LBS.

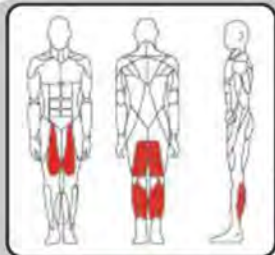

PC2222

LATERAL RAISE

- LXWXH : 94X119X150 CM.
- Weight stack : 150 LBS.

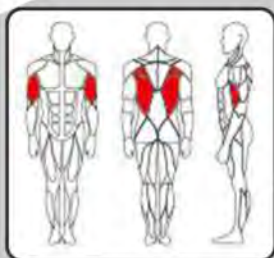

PC2223

NECK BENDING MACHINE

- LXWXH : 168X88X158 CM.
- Weight stack : 200 LBS.

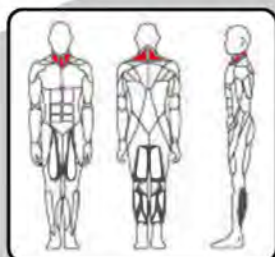

IT SERIES UNIQUE FEATURES

✧ Long lasting upholstery - 20mm thick plywood backing followed by 40mm thick foam core covered by industrial vinyl

✧ Aircraft spec 5mm American LOOS cable with 4,200 lb breaking strength. All fittings tested for 250,000 cycles using full weight stack.

✧ Easy-to-use seat with minimal adjustments and pre-stretched features optimal exercise positions.

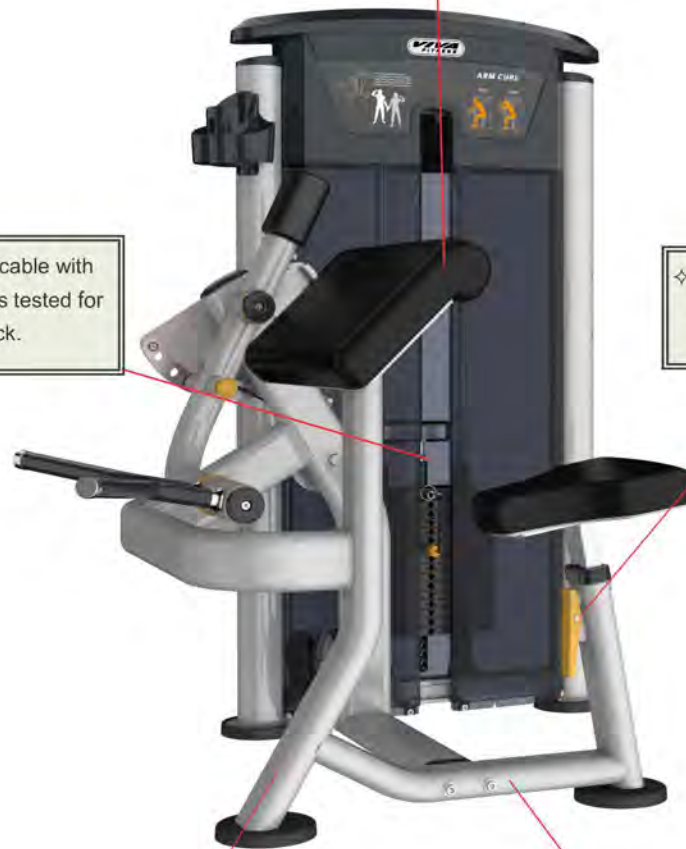

✧ 3mm thick, 50mm by 100 mm racetrack tubing, electro-welded for maximum strength.
✧ Electrostatic powder coated and heat cured paint finish for maximum durability.

✧ Compact - space efficient design requires minimal floor space.
✧ Rubber grip prevent from being slipped.

IT9501

CHEST PRESS

- LXWXH : 148X120X150 CM
- Weight Stack : 200 lbs



IT9502

LAT PULLDOWN

- LXWXH : 143X138X188 CM
- Weight Stack : 295 lbs



IT9503

ARM CURL

- LXWXH : 130X121X150 CM
- Weight Stack : 160 lbs



IT9504

PECTORAL

- LXWXH : 150X146X150 CM
- Weight Stack : 200 lbs



IT9505

LEG EXTENSION

- LXWXH : 154X119X150 CM
- Weight Stack : 200 lbs



IT9506

SEATED LEG CURL

- LXWXH : 147X120X150 CM
- Weight Stack : 200 lbs



IT9508

ABDUCTOR / ADDUCTOR

- LXWXH : 155X90X150 CM
- Weight Stack : 160 lbs



IT9509

TOTAL HIP

- LXWXH : 130X98X150 CM
- Weight Stack : 200 lbs



IT9510

LEG PRESS

- LXWXH : 180X120X150 CM
- Weight Stack : 295 lbs



IT9512

SHOULDER PRESS

- LXWXH : 156X144X151 CM
- Weight Stack : 200 lbs



IT9514

ABDOMINAL

- LXWXH : 135X115X158 CM
- Weight Stack : 200 lbs



IT9515

PEC FLY / REAR DELT

- LXWXH : 166X129X200 CM
- Weight Stack : 200 lbs



IT9516

STANDING CALF

- LXWXH : 135X115X158 CM
- Weight Stack : 235 lbs



IT9517

TRICEP PRESS

- LXWXH : 179.4X126X150 CM
- Weight Stack : 200 lbs



IT9518

ROTARY TORSO

- LXWXH : 122X120X150 CM
- Weight Stack : 160 lbs



IT9519

VERTICAL ROW

- LXWXH : 144X114X150 CM
- Weight Stack : 200 lbs



IT9520

DIP / CHIN ASSIST

- LXWXH : 122X136X220 CM
- Weight Stack : 200 lbs



IT9521

PRONE LEG CURL

- LXWXH : 147X120X150 CM
- Weight Stack : 200 lbs



IT9522

LAT PULL / SEATED ROW

- LXWXH : 135X115X158 CM
- Weight Stack : 295 lbs



IT9524

LATERAL RAISE

- LXWXH : 122X121X150 CM
- Weight Stack : 200 lbs



IT9526

GLUTE

- LXWXH : 150X124X150 CM
- Weight Stack : 200 lbs



IT9528

LEG EXTENSION / LEG CURL

- LXWXH : 135X122X150 CM
- Weight Stack : 235 lbs



IT9529

MULTI PRESS

- LXWXH : 182 X143 X166 CM
- Weight Stack : 235 lbs



IT9533

BICEP CURL / TRICEP EXTENSION

- LXWXH : 130X124X150 CM
- Weight Stack : 200 lbs



IT9534

BACK EXTENSION /
ABDOMINAL

- LXWXH : 119X118X150 CM
- Weight Stack : 200 lbs



IT7001

COUNTER BALANCED
SMITH MACHINE

- LXWXH : 138X225X229 CM.



IT7002

SEATED PREACHER CURL

- LXWXH : 101X81X88 CM.



IT7003

AB BENCH

- LXWXH : 175X94X100 CM.



IT7004

STRETCH

- LXWXH : 129X56X90 CM.



IT7005

SEATED CALF RAISE

- LXWXH : 135X75X83 CM.



IT7006

45° LEG PRESS / HACK SQUAT

- LXWXH : 225X98X146 CM.



IT7007

MULTI HYPER EXTENSION

- LXWXH : 121X73X93 CM.



IT7009

FLAT BENCH

- LXWXH : 115X90X42 CM.



IT7010

VERTICAL KNEE RAISE / DIP STAND

- LXWXH : 112X78X155 CM.



IT7011

MULTI ADJUSTABLE BENCH

- LXWXH : 121X75X46 CM.



IT7012

12 PAIRS
DUMBBELL RACK

- LXWXH : 159X81X98 CM.



IT7013

MULTI AB BENCH

- LXWXH : 173X72X89 CM.



IT7014

OLYMPIC FLAT BENCH

- LXWXH : 170X166X137 CM.



IT7015

OLYMPIC INCLINE BENCH

- LXWXH : 163X165X137 CM.



IT7016

OLYMPIC DECLINE BENCH

- LXWXH : 210X166X137 CM.



IT7017

OLYMPIC WEIGHT TREE

- LXWXH : 96X63X120 CM.



IT7018

DUMBBELL RACK

- LXWXH : 158X81X198 CM.



IT7022

UTILITY BENCH



BS SERIES UNIQUE FEATURES

◇ Long lasting upholstery - 20mm thick plywood backing followed by 40mm thick foam core covered by industrial vinyl

◇ Non absorbing PVC compound retained with aluminum collars

◇ Black painted steel weight plates with self aligning low friction sleeves
◇ Magnetic color coded pin with coiled lanyard
◇ 5mm coated steel cable for smooth and secure performance
◇ Glass fiber reinforced nylon pulleys with deep V-groove that provides secured cable positioning and fluid bearing rotation



◇ 60mm x 120mm Heavy guage flat oval steel tubing
◇ Electrostatic powder coated and heat cured paint finish for maximum durability

◇ Compact - space efficient design requires minimal floor space
◇ Rubber grip prevent from being slipped

BS008

LEG CURL/EXTENSION

- LXWXH : 132X138X153 CM.
- Weight stack : 220 LBS.



BS009

MULTI PRESS

- LXWXH : 197X153X153 CM.
- Weight stack : 220 LBS.



BS010

PULL DOWN/MID ROW

- LXWXH : 197X152X211 CM.
- Weight stack : 220 LBS.



BS011

PEC FLY/REAR DELT

- LXWXH : 179X114X202 CM.
- Weight stack : 220 LBS.



BS012

BICEPS CURL/TRICEPS PRESS

- LXWXH : 138X115X153 CM.
- Weight stack : 220 LBS.



BS013

ABDOMINAL/BACK EXTENSION

- LXWXH : 132X138X153 CM.
- Weight stack : 220 LBS.



BS015

LEG PRESS/CALF RAISE

- LXWXH : 187X118X153 CM.
- Weight stack : 220 LBS.



BS016

HIP ABDUCTION/ADDUCTION

- LXWXH : 157X94X153 CM.
- Weight stack : 220 LBS.



BS017

DIP / CHIN ASSIST

- LXWXH : 188X123X215 CM.
- Weight stack : 220 LBS.



BS110

SMITH SQUAT COMBO

- LXWXH : 224X180X213 CM



BS120

LEG PRESS / HACK SQUAT

- LXWXH : 221X113X150 CM



BS130

FUNCTIONAL TRAINER

- LXWXH : 207X122X230 CM
- WEIGHT STACK : 220 LBS X 2



BS140

CABLE CROSSOVER

- LXWXH : 360X146X239 CM
- WEIGHT STACK : 220 LBS X 2



KG BLACK SERIES UNIQUE FEATURES

- ◇ Main frame: Flat Oval tube (50'120*2.5T)
- ◇ Press arm: Round tube (60/50*3.0T) Flat oval tube (40*80*3.0T)
- ◇ Connecting assembly: Flat oval tube (50'120*2.5T)

- ◇ The cushion is made of PU and it's hardness is designed according to the principles of ergonomics and controlled to be around HBS-65±5, which assures that it's suitable for almost all users.
- ◇ The upholstery leather does not peel off or fade after getting rubbed 8000 times with a 500g weight.



WITH COUNTER

- ◇ Water bottle holder

- ◇ Front shroud is made of ABS & back shroud is made of Cold rolled steel plate

- ◇ High tempered alloy steel guide rod.
- ◇ Heavy duty steel cable with 1000 kg load capacity & tested for 100,000 rounds of endurance.
- ◇ Steel weight stacks.

- ◇ 5 level seat adjustment system

KG-6501

CHEST PRESS

- LXWXH : 145X111X168 CM
- WEIGHT STACK : 220 LBS



KG-6502

LAT PULL DOWN

- LXWXH : 183X151X203 CM
- WEIGHT STACK : 220 LBS



KG-6503

BICEP CURL

- LXWXH : 130X97X168 CM
- WEIGHT STACK : 155 LBS



KG-6505

LEG EXTENSION

- LXWXH : 136X108X168 CM
- WEIGHT STACK : 175 LBS



KG-6508

ABDUCTOR/ADDUCTOR

- LXWXH : 163X88X168 CM
- WEIGHT STACK : 175 LBS



KG-6510

LEG PRESS

- LXWXH : 195X110X168 CM
- WEIGHT STACK : 265 LBS



KG-6512

SHOULDER PRESS

- LXWXH : 164X148X168 CM
- WEIGHT STACK : 175 LBS



KG-6515

PECFLY/REARDELT

- LXWXH : 152X112X205 CM
- WEIGHT STACK : 220 LBS



KG-6517

TRICEP PRESS

- LXWXH : 137X99X168 CM
- WEIGHT STACK : 220 LBS



KG-6519

SEATED ROW

- LXWXH : 144X88X168 CM
- WEIGHT STACK : 220 LBS



KG-6520

ASSISTED CHIN/DIP

- LXWXH : 145X132X237 CM
- WEIGHT STACK : 175 LBS



KG-6521

PRONE LEG CURL

- LXWXH : 170X103X168 CM
- WEIGHT STACK : 175 LBS



KG-6522

LAT PULL/SEATED ROW

- LXWXH : 190X152X210 CM
- WEIGHT STACK : 220 LBS



KG-6528

LEG EXTENSION/CURL

- LXWXH : 140X120X166 CM
- WEIGHT STACK : 220 LBS



KG-6529

MULTI PRESS

- LXWXH : 195X146X166 CM
- WEIGHT STACK : 175 LBS



KG-6533

BICEPS/TRICEPS

- LXWXH : 125X125X166 CM
- WEIGHT STACK : 175 LBS



KG-6535

SEATED HORIZONTAL PULLEY

- LXWXH : 179X107X168 CM
- WEIGHT STACK : 220 LBS



KG-6545

CABLE CROSSOVER

- LXWXH : 370X89X225 CM
- WEIGHT STACK : 220 LBS X 2

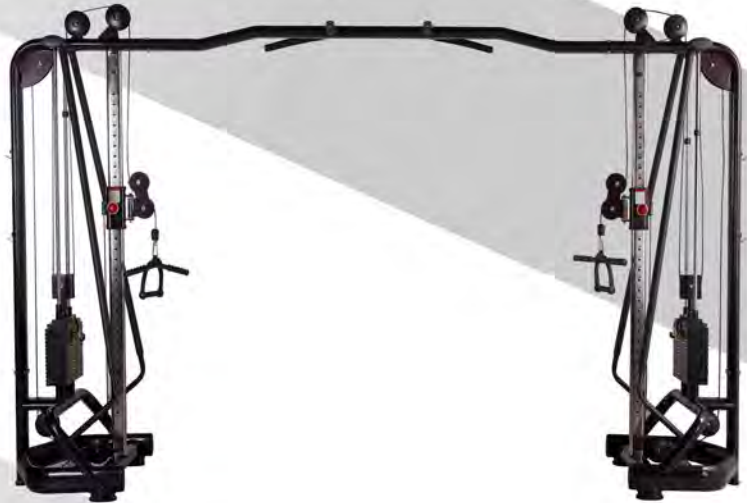

KG-6546

FUNCTIONAL TRAINER

- LXWXH : 163X108X225 CM
- WEIGHT STACK : 220 LBS X 2



KG-6547

SMITH MACHINE

- LXWXH : 230X140X250 CM



KG-6555

OLYMPIC FLAT BENCH

- LXWXH : 168X168X120 CM



KG-6556

OLYMPIC DECLINE BENCH

- LXWXH : 196X157X250 CM



KG-6557

OLYMPIC INCLINE BENCH

- LXWXH : 189X158X139 CM



KG-6558

BACK EXTENSION BENCH

- LXWXH : 137X74X84 CM



KG-6559

AB BENCH

- LXWXH : 188X75X110 CM



KG-6560

T ARM MACHINE

- LXWXH : 189X85X81 CM



KG-6561

STRETCH MACHINE

- LXWXH : 157X52X94 CM



KG-6562

FLAT BENCH

- LXWXH : 150X73X45 CM



KG-6563

MULTI ADJUSTABLE BENCH

- LXWXH : 146X60X47 CM



KG-6564

UTILITY BENCH

- LXWXH : 115X55X90 CM



KG-6565

BARBELL RACK

- LXWXH : 116X81X142 CM



KG-6566

PREACHER CURL BENCH

- LXWXH : 97X74X97 CM



VIVA[®]
FITNESS

PushYourself



BEAST SERIES UNIQUE FEATURES

✦ Instructive - simple, step-by-step instructions and training tips help users get the most out of their exercise. Makes exercise easy and enjoyable

✦ Aesthetic looking bottle holder located at a convenient height.



WITH COUNTER

✦ Newly designed state of art frame to give ultimate strength to the machine.
 ✦ Tubing: 3mm, 50mm by 100mm race track tubing
 ✦ Color: metallic silver gray
 ✦ Finish: Powder-coated painting color for premium look and also for protection from rusting.

✦ Strong ABS cover for user safety and machine protection.

✦ Seats made from integrated foam to give perfect support and avoid de-shaping even after long use.

✦ Easy-to-use, minimal adjustments and pre-stretch features allow optimal exercise positions.
 ✦ Made from stainless tube to avoid rusting.

✦ Aircraft spec 5mm American LOOS cable with 3,500 lbs breaking strength. End fittings tested to 200,000 cycles using full weight stack.
 ✦ Pure steel weight stacks.
 ✦ D: 106.2mm powerful nylon pulley in full alignment with cable for lifetime use.

✦ Compact - space efficient design requires minimal floor space.
 ✦ Rubber grip prevent from being slipped.

BEAST 1

CHEST PRESS

- LXWXH : 117X157X163 CM
- WEIGHT STACK : 200 LBS



BEAST 2

SHOULDER PRESS

- LXWXH : 144X156X163 CM
- WEIGHT STACK : 200 LBS



BEAST 3

INDEPENDENT ARM

- LXWXH : 106X153X163 CM
- WEIGHT STACK : 175 LBS



BEAST 4

TRICEP PRESS

- LXWXH : 168X135X163 CM
- WEIGHT STACK : 175 LBS



BEAST 5

MULTI PRESS

- LXWXH : 186X138X162 CM
- WEIGHT STACK : 200 LBS



BEAST 6

PEC FLY / REAR DELT

- LXWXH : 152X117X206 CM
- WEIGHT STACK : 200 LBS



BEAST 7

LAT PULL / SEATED ROW

- LXWXH : 193X113X219 CM
- WEIGHT STACK : 220 LBS



BEAST 8

LOW ROW

- LXWXH : 144X104X163 CM
- WEIGHT STACK : 175 LBS



BEAST 9

ASSISTED CHIN DIP

- LXWXH : 137X142X233 CM
- WEIGHT STACK : 200 LBS



BEAST 10

ABDOMINAL

- LXWXH : 131X128X163 CM
- WEIGHT STACK : 175 LBS



BEAST 11

ABDUCTOR / ADDUCTOR

- LXWXH : 144X148X163 CM
- WEIGHT STACK : 175 LBS



BEAST 12

SEATED LEG CURL

- LXWXH : 166X138X163 CM
- WEIGHT STACK : 175 LBS



BEAST 13

PRONE LEG CURL

- LXWXH : 173X6X131X163 CM
- WEIGHT STACK : 200 LBS



BEAST 14

LEG EXTENSION

- LXWXH : 151X138X163 CM
- WEIGHT STACK : 200 LBS



BEAST 15

LEG CURL / LEG EXTENSION

- LXWXH : 158X130X163 CM
- WEIGHT STACK : 200 LBS



BEAST 16

LEG PRESS

- LXWXH : 177X124X163 CM
- WEIGHT STACK : 220 LBS



BEAST 17

PRONE LEG CURL / EXTENSION

- LXWXH : 178X120X163 CM
- WEIGHT STACK : 200 LBS



BEAST 18

SMITH MACHINE

- LXWXH : 229X138X234 CM
- COUNTER BALANCED



BEAST 35

LATERAL RAISE

- LXWXH : 130X151X163 CM
- WEIGHT STACK : 200 LBS

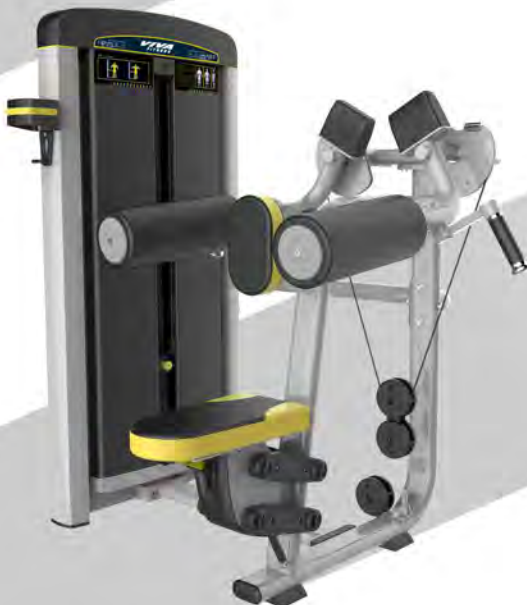

BEAST 36

GLUTE MACHINE

- LXWXH : 214X115X163 CM
- WEIGHT STACK : 220 LBS



BEAST 21

OLYMPIC FLAT BENCH

- LXWXH : 164X153X119 CM



BEAST 22

OLYMPIC INCLINE BENCH

- LXWXH : 184X153X140 CM



BEAST 23

OLYMPIC DECLINE BENCH

- LXWXH : 200X153X119 CM



BEAST 24

HYPER EXTENSION

- LXWXH : 139X98X89 CM



BEAST 25

VERTICAL KNEE
RAISE

- LXWXH : 122X85X161 CM



BEAST 26

SEATED CALF

- LXWXH : 125X60X91 CM



BEAST 27

AB BENCH

- LXWXH : 182X99X103 CM



BEAST 28

STRETCH

- LXWXH : 135X49X100 CM



BEAST 29

ADJUSTABLE AB
BENCH

- LXWXH : 184X73X94 CM



BEAST 30

FLAT BENCH

- LXWXH : 146X73X44 CM



BEAST 31

MULTI ADJUSTABLE BENCH

- LXWXH : 143X59X44 CM



BEAST 32

UTILITY BENCH

- LXWXH : 108X53X90 CM



BEAST 34

45° LEG PRESS

- LXWXH : 242X168X140 CM



BEAST 37

PLATE TREE

- LXWXH : 78X78X110 CM



BEAST 38

PREACHER CURL BENCH

- LXWXH : 97X71X101 CM



BEAST 39

KNEE CHIN DIP

- LXWXH : 112X147X230 CM



BEAST 40

DUMBBELL RACK

- LXWXH : 209X81X83 CM





VIVA[®]
FITNESS

PushYourself

TP SERIES UNIQUE FEATURES

◇ Long lasting upholstery - 20mm thick plywood backing followed by 40mm thick foam core covered by industrial vinyl

◇ Made in Japan 6mm thick wire with maximum load capacity of 3000 LBS

◇ Easy-to-use seat with minimal adjustments and pre-stretched features for optimal exercise positions.

◇ 50x100mm flat oval tube strong steel structure
◇ Electrostatic powder coated and heat cured paint finish for maximum durability.

◇ Compact - space efficient design requires minimal floor space.
◇ Rubber grip prevent from being slipped.



TP-01

CHEST PRESS

- LXWXH : 155X150X163 CM.
- Weight stack : 220 LBS.



TP-02

SHOULDER PRESS

- LXWXH : 198X145X163 CM.
- Weight stack : 220 LBS.



TP-04

PEC FLY / REAR DELT

- LXWXH : 149X134X208 CM.
- Weight stack : 220 LBS.



TP-05

ARM CURL

- LXWXH : 136X116X163 CM.
- Weight stack : 175 LBS.



TP-07

LATERAL RAISE

- LXWXH : 134X132X163 CM.
- Weight stack : 220 LBS.



TP-08

PULLDOWN

- LXWXH : 172X158X183 CM.
- Weight stack : 220 LBS.



TP-13

LEG EXTENSION

- LXWXH : 132X122X163 CM.
- Weight stack : 220 LBS.



TP-14

SEATED LEG CURL

- LXWXH : 166X123X163 CM.
- Weight stack : 220 LBS.



TP-15

PRONE LEG CURL

- LXWXH : 163X112X163 CM.
- Weight stack : 220 LBS.



TP-16

LEG PRESS

- LXWXH : 198X122X163 CM.
- Weight stack : 264 LBS.



TP-22

ISO LONG PULL

- LXWXH : 200X117X163 CM.
- Weight stack : 220 LBS.



TP-21

CABLE CROSSOVER

- LXWXH : 386X70X233 CM.
- Weight stack : 220 LBS X 2.

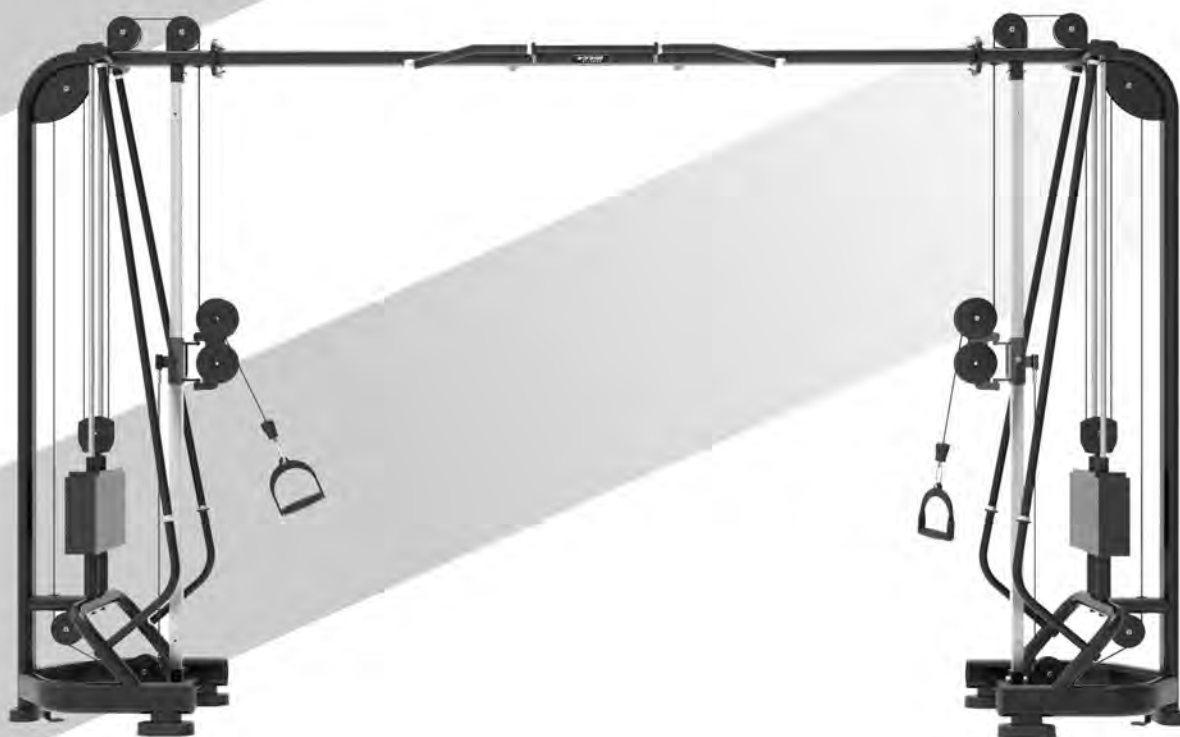

TP-23

FUNCTIONAL TRAINER

- LXWXH : 193X100X233 CM.
- Weight stack : 220 LBS X 2.



TP-24

DIP CHIN ASSIST

- LXWXH : 157X123X225 CM.
- Weight stack : 220 LBS.



TP-25

SEATED LEG CURL / EXTENSION

- LXWXH : 172X125X163 CM.
- Weight stack : 220 LBS.



TP-26

BICEPS / TRICEPS

- LXWXH : 152X119X163 CM.
- Weight stack : 175 LBS.



TP-28

PRONE LEG CURL / SEATED EXTENSION

- LXWXH : 126X186X163 CM.
- Weight stack : 220 LBS.



TP-29

MULTI PRESS

- LXWXH : 150X197X163 CM.
- Weight stack : 220 LBS.



TP-30

LAT PULL / SEATED ROW

- LXWXH : 186X167X218 CM.
- Weight stack : 220 LBS.



TP-32

MULTI HIP

- LXWXH : 120X106X163 CM.
- Weight stack : 220 LBS.



SELECT LINE UNIQUE FEATURES



BR01

CHEST PRESS

- LXWXH: 104X145X163 CM
- WEIGHT STACK : 220 LBS



BR02

SHOULDER PRESS

- LXWXH: 152X142X163 CM
- WEIGHT STACK : 220 LBS



BR04

PEC FLY / REAR DELT

- LXWXH: 124X142X180 CM
- WEIGHT STACK : 220 LBS



BR05

BICEP CURL

- LXWXH: 114X104X140 CM
- WEIGHT STACK : 190 LBS



BR07

LATERAL RAISE

- LXWXH: 107X94X140 CM
- WEIGHT STACK : 190 LBS



BR08

LAT PULLDOWN

- LXWXH: 137X84X226 CM
- WEIGHT STACK : 220 LBS



BR13

LEG EXTENSION

- LXWXH: 119X104X163 CM
- WEIGHT STACK : 220 LBS



BR14

SEATED LEG CURL

- LXWXH: 140X86X140 CM
- WEIGHT STACK : 220 LBS



BR15

PRONE LEG CURL

- LXWXH: 165X99X140 CM
- WEIGHT STACK : 220 LBS



BR24

DIP / CHIN ASSIST

- LXWXH: 118X113X221 CM
- WEIGHT STACK : 220 LBS



BR25

SEATED LEG CURL / LEG EXTENSION

- LXWXH: 140X86X140 CM
- WEIGHT STACK : 220 LBS



BR26

TRICEP / BICEP

- LXWXH: 114X104X140 CM
- WEIGHT STACK : 190 LBS



BR27

ABDUCTOR / ADDUCTOR

- LXWXH: 155X67X180 CM
- WEIGHT STACK : 190 LBS



BR28

PRONE LEG CURL / LEG EXTENSION

- LXWXH: 117X102X140 CM
- WEIGHT STACK : 220 LBS



BR29

MULTI PRESS

- LXWXH: 152X142X163 CM
- WEIGHT STACK : 220 LBS



BR30

LAT PULL / SEATED ROW

- LXWXH: 137X84X226 CM
- WEIGHT STACK : 220 LBS



BR33

BACK EXTENSION / ABDOMINAL

- LXWXH: 117X102X140 CM
- WEIGHT STACK : 190 LBS



BR34

BUTTERFLY

- LXWXH: 124X142X180 CM
- WEIGHT STACK : 220 LBS



BR35

ROWING MACHINE

- LXWXH: 132X86X180 CM
- WEIGHT STACK : 220 LBS



BR36

FUNCTIONAL TRAINER

- LXWXH: 105X176X225 CM
- WEIGHT STACK : 220 LBS X 2



BR37

SMITH MACHINE

- LXWXH: 142X221X236 CM
- COUNTER BALANCED



CONQUER LINE UNIQUE FEATURES



PS2001

PRONE LEG CURL

- LXWXH: 165X96X153 CM
- WEIGHT STACK : 210 LBS



PS2002

LEG EXTENSION

- LXWXH: 156X103X153 CM
- WEIGHT STACK : 240 LBS



PS2003

LEG PRESS

- LXWXH: 209X106X153 CM
- WEIGHT STACK : 240 LBS



PS2006

SHOULDER PRESS

- LXWXH: 175X135X153 CM
- WEIGHT STACK : 240 LBS



PS2007

PEC FLY / REAR DELT

- LXWXH: 186X131X202 CM
- WEIGHT STACK : 240 LBS



PS2008

CHEST PRESS

- LXWXH: 148X105X181 CM
- WEIGHT STACK : 240 LBS



PS2009

DIP / CHIN / ASSIST

- LXWXH: 139X122X235 CM
- WEIGHT STACK : 195 LBS



PS2021

ABDUCTOR / ADDUCTOR

- LXWXH: 161X75X153 CM
- WEIGHT STACK : 200 LBS



PS2033

LONG PULL

- LXWXH: 180X133X187 CM
- WEIGHT STACK : 240 LBS



PS2034

VERTICAL ROW

- LXWXH: 149X129X151 CM
- WEIGHT STACK : 210 LBS



PS2084

MULTI PRESS

- LXWXH: 181X146X153 CM
- WEIGHT STACK : 240 LBS



PS2085

LAT PULL / SEATED ROW

- LXWXH: 197X114X224 CM
- WEIGHT STACK : 240 LBS



PS2086

SEATED LEG CURL / EXTENSION

- LXWXH: 145X102X153 CM
- WEIGHT STACK : 240 LBS



PS2087

BICEP / TRICEP

- LXWXH: 133X106X153 CM
- WEIGHT STACK : 240 LBS



E SERIES UNIQUE FEATURES



E5001

PRONE LEG CURL

- LXWXH: 152X99X135 CM
- WEIGHT STACK : 210 LBS



E5002

LEG EXTENSION

- LXWXH: 130X99X135 CM
- WEIGHT STACK : 240 LBS



E5003

SEATED LEG PRESS

- LXWXH: 190X110X162 CM
- WEIGHT STACK : 255 LBS



E5005

LATERAL RAISE

- LXWXH: 91X115X150 CM.
- WEIGHT STACK : 120 LBS



E5006

SHOULDER PRESS

- LXWXH: 185X122X132 CM
- WEIGHT STACK : 240 LBS



E5007

PEC FLY / REAR DELT

- LXWXH: 124X99X211 CM
- WEIGHT STACK : 240 LBS



E5008

CHEST PRESS

- LXWXH: 132X130X135 CM
- WEIGHT STACK : 240 LBS



E5009

DIP CHIN

- LXWXH: 155X137X236 CM
- WEIGHT STACK : 200 LBS



E5013

INCLINE CHEST PRESS

- LXWXH: 185X122X132 CM
- WEIGHT STACK : 240 LBS



E5023

SEATED LEG CURL

- LXWXH: 165X94X135 CM
- WEIGHT STACK : 240 LBS



E5030

BICEP CURL

- LXWXH: 119X89X135 CM
- WEIGHT STACK : 140 LBS



E5033

LONG PULL

- LXWXH: 282X109X236 CM
- WEIGHT STACK : 240 LBS



E5034

VERTICAL ROW

- LXWXH: 155X132X160 CM
- WEIGHT STACK : 210 LBS



E5035

LAT PULL DOWN

- LXWXH: 185X109X234 CM
- WEIGHT STACK : 240 LBS



E5084

MULTI PRESS

- LXWXH: 200X135X162 CM
- WEIGHT STACK : 240 LBS



E5088

ABDOMINAL / BACK EXTENSION

- LXWXH: 131X99X162 CM
- WEIGHT STACK : 240 LBS



E5086

LEG CURL /
LEG EXTENSION

- LXWXH: 140X120X162 CM
- WEIGHT STACK : 240 LBS



E5087

BICEP / TRICEP

- LXWXH: 140X120X162 CM
- WEIGHT STACK : 140 LBS



E5089

ABDUCTOR / ADDUCTOR

- LXWXH: 155X90X162 CM
- WEIGHT STACK : 210 LBS



E3046

STANDING MULTI FLIGHT

- LXWXH: 142X89X200 CM
- WEIGHT STACK : 175 LBS



E3016

CABLE CROSSOVER

- LXWXH: 447X109X231 CM
- WEIGHT STACK : 220 LBS X 2



E1017

FUNCTIONAL TRAINER

- LXWXH: 105X176X225 CM
- WEIGHT STACK : 220 LBS X 2



E5200

ADJUSTABLE HI/LO PULLEY

- LXWXH : 99X124X227 CM
- WEIGHT STACK : 220 LBS X 1



E5202

4 STATION JUNGLE GYM

- LXWXH : 350X228X227 CM
- WEIGHT STACK : 220 LBS X 4



E5203

CABLE CROSSOVER

- WEIGHT STACK : 220 LBS X 2



E5204

5 STATION JUNGLE GYM

- WEIGHT STACK : 220 LBS X 5



E3036

FLAT BENCH

- LXWXH: 141X68X42 CM



E3037

ADJUSTABLE AB BENCH

- LXWXH: 164X68X99 CM



E3038

MULTI PURPOSE BENCH

- LXWXH: 106X68X90 CM



E3039

ADJUSTABLE BENCH

- LXWXH: 138X68X69 CM



E1080

AB COASTER

- LXWXH : 185X72X145 cm
- Maximum user weight : 150 kg.



E1082

AB COASTER

- LXWXH : 164x78x146 CM.
- Maximum user weight : 180 kg.



E3041

OLYMPIC DECLINE BENCH

• LXWXH: 209X170X122 CM



E3042

OLYMPIC INCLINE BENCH

• LXWXH: 196X170X140 CM



E3043

OLYMPIC FLAT BENCH

• LXWXH: 174X170X122 CM



E3044

SEATED PREACHER CURL

• LXWXH: 113X84X88 CM



E3045

HYPER EXTENSION

• LXWXH: 121X89X67 CM



E3047

DIP / VERTICAL KNEE RAISE

• LXWXH: 127X71X160 CM



E3048

POWER CAGE

• LXWXH: 157X124X234 CM

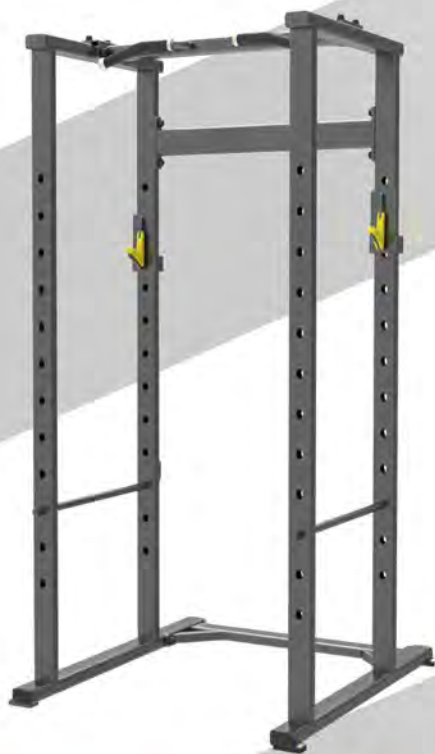

E3050

SQUAT RACK

• LXWXH: 173X170X178 CM



E3055

PLATE LOADED LEG PRESS

• LXWXH: 217X161X126 CM



E3056

PLATE LOADED LEG PRESS

• LXWXH: 221X63X135 CM



E3057

PLATE LOADED
HACK SQUAT

- LXWXH: 224X163X126 CM



E3061

T BAR

- LXWXH : 185x79x119 CM



E3063

SMITH MACHINE

- LXWXH: 142X221X236 CM
- COUNTER BALANCED

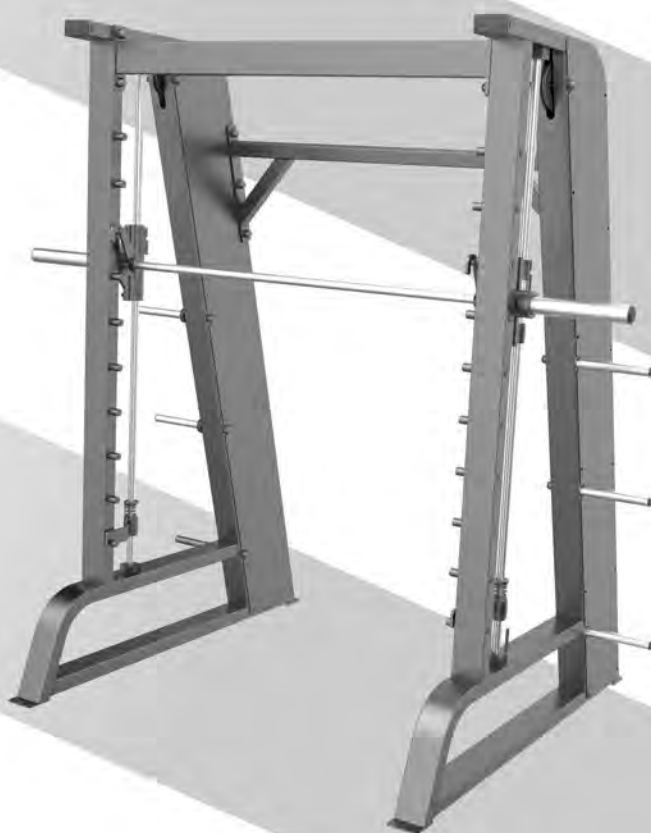

E3062

SEATED CALF

- LXWXH: 150X71X99 CM



E3065

SUPER SQUAT

- LXWXH: 185X79X119 CM



E3092

BOOTY MACHINE

- LXWXH: 201X163X147 CM.



E6233

WEIGHT PLATE BASE

- *LXWXH: 143X74X43 CM.



E3077

DUMBBELL RACK

- LXWXH: 72X248X81 CM



SS SERIES UNIQUE FEATURES

✦ Instructive - simple, step-by-step instructions and training tips help users get the most out of their exercise. Makes exercise easy and enjoyable

✦ Steel weight stack cover for user safety and machine protection.

✦ Seats made from integrated foam to give perfect support and avoid de-shaping even after long use.

✦ Aircraft spec 5.7mm American LOOS cable with 3,500 lbs breaking strength. End fittings tested to 200,000 cycles using full weight stack.
✦ Pure steel weight stacks.
✦ D: 106.2mm powerful nylon pulley in full alignment with cable for lifetime use.

✦ Classic frame design for professional training
✦ Tubing: 3mm, 50mm by 100mm flat oval tubing
✦ Finish: Powder-coated painting color for premium look and also for protection from rusting.

✦ Compact - space efficient design requires minimal floor space.
✦ Rubber grip prevent from being slipped.



SS01

CHEST PRESS

- LXWXH : 138X113X161 CM
- Weight Stack : 220 lbs



SS02

SHOULDER PRESS

- LXWXH : 140X135X161 CM
- Weight Stack : 220 lbs



SS03

BICEP CURL

- LXWXH : 117X119X161 CM
- Weight Stack : 175 lbs



SS04

TRICEP PRESS

- LXWXH : 146X123X161 CM
- Weight Stack : 220 lbs



SS05

MULTI PRESS

- LXWXH : 189X123X161 CM
- Weight Stack : 220 lbs



SS06

PEC FLY / REAR DELT

- LXWXH : 162X105X200 CM
- Weight Stack : 220 lbs



SS07

LAT PULL / SEATED ROW

- LXWXH : 151X142X226 CM
- Weight Stack : 220 lbs



SS08

LOW ROW

- LXWXH : 175X116X180 CM
- Weight Stack : 220 lbs



SS09

ASSISTED CHIN DIP

- LXWXH : 165X118X229 CM
- Weight Stack : 220 lbs



SS10

ABDOMINAL

- LXWXH : 120X112X161 CM
- Weight Stack : 175 lbs



SS11

ABDUCTOR / ADDUCTOR

- LXWXH : 155X131X161 CM
- Weight Stack : 175 lbs



SS12

SEATED LEG CURL

- LXWXH : 155X127X161 CM
- Weight Stack : 220 lbs



SS13

PRONE LEG CURL

- LXWXH : 169X115X161 CM
- Weight Stack : 220 lbs



SS14

LEG EXTENSION

- LXWXH : 134X127X161 CM
- Weight Stack : 220 lbs



SS15

SEATED LEG CURL / LEG EXTENSION

- LXWXH : 139X127X161 CM
- Weight Stack : 220 lbs



SS17

LAT PULL DOWN

- LXWXH : 124X142X224 CM
- Weight Stack : 220 lbs



SS18

ROTARY TORSO

- LXWXH : 131X107X161 CM
- Weight Stack : 175 lbs



SS20

PRONE LEG CURL / LEG EXTENSION

- LXWXH : 115X113X161 CM
- Weight Stack : 220 lbs



DFT601

PRONE LEG CURL

- LXWXH : 150x100x137 CM.
- Weight Stack:175 lbs.



DFT602

LEG EXTENSION

- LXWXH : 130x100x137 CM.
- Weight Stack:175 lbs.



DFT606

SHOULDER PRESS

- LXWXH : 185x125x137 CM.
- Weight Stack:220 lbs.



DFT607

PEC FLY / REAR DELT

- LXWXH : 125x100x210 CM.
- Weight Stack:220 lbs.



DFT609

DIP CHIN MACHINE

- LXWXH : 155x137x236 CM.
- Weight Stack:175 lbs.



DFT616

CABLE CROSSOVER

- LXWXH : 335x110x235 CM.
- Weight Stack:220 LBS X 2.



DFT630

ARM CURL

- LXWXH : 114x94x137 CM.
- Weight Stack:175 lbs.



DFT635

LAT PULL

- LXWXH : 185x110x234 CM.
- Weight Stack:220 lbs.



DFT690

BICEP / TRICEP

- LXWXH : 110X114X163 CM
- Weight Stack : 200 lbs



DFT691

LAT PULL / SEATED ROW

- LXWXH : 170X97X223 CM
- Weight Stack : 200 lbs



DFT692

LEG CURL /
LEG EXTENSION

- LXWXH : 122X120X163 CM
- Weight Stack : 200 lbs



DFT693

ABDUCTOR / ADDUCTOR

- LXWXH : 157X88X163 CM
- Weight Stack : 200 lbs



DFT694 MULTI PRESS

- LXWXH : 157X88X163 CM
- Weight Stack : 200 lbs



DFT636 FLAT BENCH

- LXWXH : 140x68x42 CM.



DFT637 MULTI AB BENCH

- LXWXH : 165x68x100 CM.



DFT638 UTILITY BENCH

- LXWXH: 106X68X90 CM



DFT639

ADJUSTABLE BENCH

- LXWXH : 138x68x69 CM.



DFT640

GLUTE HAM DEVELOPER (GHD)



DFT641

OLYMPIC DECLINE BENCH

- LXWXH : 210x170x125 CM.



DFT642

OLYMPIC INCLINE BENCH

- LXWXH : 196x170x140 CM.



DFT643

OLYMPIC FLAT BENCH

- LXWXH : 174x170x125 CM.



DFT644

SEATED PREACHER CURL

- LXWXH : 132x84x97 CM.



DFT645

HYPER EXTENSION BENCH

- LXWXH : 122x89x68 CM.



DFT646

TRIPLE STORAGE RACK

- Can store upto 12 barbells, 24 weight plates and 8 pcs kettle bell.



DFT647

VERTICAL KNEE RAISE /
DIP STAND

- LXWXH : 127x70x96 CM.



DFT649

DUMBBELL RACK

- LXWXH : 234x70x77 CM.



DFT650

SQUAT RACK

- LXWXH : 173x170x180 CM.



DFT656

PLATE LOADING LEG PRESS

- LXWXH : 222x165x135 CM.



DFT657

PLATE LOADING HACK SQUAT

- LXWXH : 225x125x125 CM.



DFT661

T BAR

- LXWXH :185x80x120 CM.



DFT662

SEATED CALF

- LXWXH : 150x70x100 CM.



DFT663

SMITH MACHINE

- Counter Balanced.



DFT671/679

FUNCTIONAL TRAINER

- LXWXH : 162x117x235 CM.
- Weight Stack:220 LBS x 2.



DFT683

SUPER SQUAT

- LXWXH: 185X79X119 CM



DFT698

LEG PRESS / HACK SQUAT

- LXWXH : 208X92X149 CM



SL SERIES UNIQUE FEATURES

Easy to use, neat appearance, the SL line is a high quality commercial plate loaded series. The user-friendly design makes working out more simple, efficient, comfortable and satisfying.



SL7001

CHEST PRESS

- LXWXH: 194X137X171 CM
- MAX WEIGHT CAPACITY:300Kg/660Lbs



SL7002

PULL DOWN

- LXWXH: 148X149X197 CM
- MAX WEIGHT CAPACITY:300Kg/660Lbs



SL7003

SHOULDER PRESS

- LXWXH: 156X182X149 CM
- MAX WEIGHT CAPACITY:300Kg/660Lbs



SL7004

LOW ROW

- LXWXH: 176X145X165 CM
- MAX WEIGHT CAPACITY:300Kg/660Lbs.



SL7005

INCLINE CHEST PRESS

- LXWXH: 190X152X178 CM
- MAX WEIGHT CAPACITY:300Kg/660Lbs.



SL7006

LEG PRESS

- LXWXH: 223X142X142 CM
- MAX WEIGHT CAPACITY:400Kg/880Lbs.



SL7007

ROW

- LXWXH: 182X150X133 CM
- MAX WEIGHT CAPACITY:300Kg/660Lbs.



SL7008

REAR KICK

- LXWXH: 168X123X164 CM
- MAX WEIGHT CAPACITY:150Kg/330Lbs.



SL7009

OLYMPIC POWER RACK

- LXWXH: 203X145X228 CM



SL7010

PLATE RACK

- LXWXH: 89X63X122 CM



SL7011

FID BENCH

- LXWXH: 135X67X135 CM



SL7012

FID BENCH

- LXWXH: 155X67X135 CM



SL7013

GLUTE HAM BENCH

- LXWXH: 156X91X148 CM



SL7014

HALF RACK

- LXWXH: 139X175X244 CM



SL7016

DUMBBELL RACK

- LXWXH : 226X76X74CM



SL7017

SEATED CALF RAISE

- LXWXH: 146X77X85 CM
- MAX WEIGHT CAPACITY: 150 KG/330 LBS



SL7018

STANDING PREACHER CURL

- LXWXH : 114X86X102 CM



SL7019

INCLINE ROW

- LXWXH : 196X102X125 CM
- Maximum Weight Capacity : 150kg / 330 LBS



SL7020

45° LEG PRESS

- LXWXH : 250X187X154CM
- MAX WEIGHT CAPACITY:450Kg/990Lbs.



SL7021

HACK SQUAT

- LXWXH : 220X188X129CM
- MAX WEIGHT CAPACITY:400Kg/880Lbs



SL7022

UTILITY BENCH

- LXWXH : 119X63X82 CM.



SL7023

BICEP CURL

- LXWXH : 140X105X120 CM.
- MAX WEIGHT CAPACITY:300Kg/660Lbs.



SL7024

TRICEP DIP

- LXWXH : 173X158X120 CM
- MAX WEIGHT CAPACITY: 300 KG/660 LBS



SL7025

LEG EXTENSION

- LXWXH: 127X169X100 CM.
- MAX WEIGHT CAPACITY: 300 KG/660 LBS



SL7026

STANDING LEG CURL

- LXWXH : 140X104X120 CM
- MAX WEIGHT CAPACITY: 120 KG/264 LBS



SL7027

BARBELL RACK

- LXWXH : 95X91X161 CM



SL7028

FLAT BENCH PRESS

• LXWXH : 191X173X132 CM



SL7029

INCLINE BENCH PRESS

• LXWXH : 206X174X150 CM



SL7030

DECLINE BENCH PRESS

• LXWXH : 219X174X132 CM



SL7031

SHOULDER BENCH PRESS

• LXWXH : 172X126X192 CM



SL7032

STANDING CALF RAISE

- LXWXH : 162X138X173 CM
- MAX WEIGHT CAPACITY: 300 KG/660 LBS



SL7034

SQUAT

- LXWXH : 226X126X180 CM
- MAX WEIGHT CAPACITY: 400 KG/880 LBS



SL7035

FLAT BENCH

- LXWXH : 128X63X53 CM
- MAX WEIGHT CAPACITY: 400 KG/880 LBS



SL7036

ABDOMINAL

- LXWXH: 162X127X164 CM.
- MAX WEIGHT CAPACITY: 300 KG/660 LBS



SL7041

SUPER OLYMPIC BENCH

• LXWXH : 241X174X162 CM



SL7043

MULTI AB BENCH

• LXWXH : 172X63X91 CM



SL7042

MAGIC RACK /
SMITH MACHINE

• LXWXH : 232X224X239 CM



SL7044

STRETCH MACHINE

• LXWXH : 157X63X126 CM



SL7045

VERTICAL KNEE RAISE / DIP STAND

• LXWXH : 119X77X136 CM



SL7046

ISO-LATERAL SUPER CHEST PRESS

• LXWXH : 250X174X162 CM



SL7047

HYPER EXTENSION BENCH

• LXWXH : 134X95X77 CM



JPL302

SHOULDER PRESS

- LXWXH : 129X128X146 CM
- MAX WEIGHT CAPACITY : 250Kg/550Lbs



JPL303

CHEST PRESS

- LXWXH : 122X141X164 CM
- MAX WEIGHT CAPACITY : 250Kg/550Lbs



JPL304

PULL DOWN

- LXWXH : 112X138X124 CM
- MAX WEIGHT CAPACITY : 250Kg/550Lbs



JPL305

ROW

- LXWXH : 118X139X124 CM
- MAX WEIGHT CAPACITY : 250Kg/550Lbs



JPL306

LOW ROW

- LXWXH : 120X122X163 CM
- MAX WEIGHT CAPACITY : 250Kg/550Lbs



JPL307

LEG PRESS

- LXWXH : 145X210X135 CM
- MAX WEIGHT CAPACITY : 300Kg/660Lbs



JPL308

INCLINE CHEST PRESS

- LXWXH : 153X103X164 CM
- MAX WEIGHT CAPACITY : 250Kg/550Lbs



JPL310

REAR KICK

- LXWXH : 111X143X164 CM
- MAX WEIGHT CAPACITY : 250Kg/550Lbs



JPL312

TRICEP DIP

- LXWXH : 147X154X86 CM
- MAX WEIGHT CAPACITY : 250Kg/550Lbs



JPL313

BICEP CURL

- LXWXH : 106X139X101 CM
- MAX WEIGHT CAPACITY : 250Kg/550Lbs



JPL314

STANDING LEG CURL

- LXWXH : 144X117X142 CM
- MAX WEIGHT CAPACITY : 250Kg/550Lbs



JPL315

LEG EXTENSION

- LXWXH : 124X126X117 CM
- MAX WEIGHT CAPACITY : 250Kg/550Lbs



JPL316

LINEAR LEG PRESS

- LXWXH : 270X157X150 CM
- MAX WEIGHT CAPACITY : 400Kg/880Lbs



JPL317

LINEAR LEG PRESS

- LXWXH : 270X157X150 CM
- MAX WEIGHT CAPACITY : 400Kg/880Lbs



JPL318

INCLINE PEC FLY

- LXWXH : 163X164X110 CM
- MAX WEIGHT CAPACITY : 250Kg / 550Lbs



JPL319

POWER RACK

- LXWXH : 204X116X228 CM



JPL320

CHEST PRESS / LAT PULLDOWN

- LXWXH : 215X169X203 CM
- MAX WEIGHT CAPACITY : 250Kg / 550Lbs



JPL321

MULTI ADJUSTABLE BENCH

- LXWXH : 156X74X41 CM



JPL322

LUNGE / DEADLIFT / SHRUGS

- LXWXH : 162X154X87 CM
- MAX WEIGHT CAPACITY : 400Kg/880Lbs



JPL 323

ISO FID BENCH

- LXWXH : 188X201X175 CM
- MAX WEIGHT CAPACITY : 160Kg / 350Lbs



JPL 329

SMITH SQUAT COMBO

- WITH COUNTER BALANCE MACHINE
- LXWXH : 200X142X218 CM



JPL 327

POWER RACK / SMITH MACHINE

- LXWXH : 183X221X219 CM



JPL 328

POWER RACK / SMITH MACHINE

- WITH COUNTER BALANCE
- LXWXH : 183X221X219 CM



A photograph of a very muscular man with a beard and dark hair, wearing blue athletic shorts and a thin necklace. He is standing in a gym, looking towards the camera with a serious expression. The background is blurred, showing gym equipment and other people. In the top right corner, there is a red logo for 'VIVA FITNESS' and a hashtag '#PushYourself'.

VIVA[®]
FITNESS

#PushYourself

FL6002

PREACHER CURL BENCH

- Paint Finish : Electrostatic Powder Coating
- Seats : Tear resistant leatherite
- Pipe Size : 100x50x2.5 mm
- LXWXH : 117X75X90 CM



FL6005

SEATED CALF RAISE

- Paint Finish : Electrostatic Powder Coating
- Seats : Tear resistant leatherite
- Pipe Size : 100x50x2.5 mm
- LXWXH : 132X67X91 CM



FL6007

HYPER EXTENSION

- Paint Finish : Electrostatic Powder Coating
- Seats : Tear resistant leatherite
- Pipe Size : 100x50x2.5 mm
- LXWXH : 125X68X90 CM



FL6009

FLAT BENCH

- Paint Finish : Electrostatic Powder Coating
- Seats : Tear resistant leatherite
- Pipe Size : 100x50x2.5 mm
- LXWXH : 128X60X49 CM



FL6010

VERTICAL KNEE RAISE / DIP STAND

- Paint Finish : Electrostatic Powder Coating
- Seats : Tear resistant leatherite
- Pipe Size : 100x50x2.5 mm
- LXWXH : 109X75X158 CM



FL6011

MULTI ADJUSTABLE BENCH

- Flat / Incline / Decline position
- Paint Finish : Electrostatic Powder Coating
- Seats : Tear resistant leatherite
- Pipe Size : 100x50x2.5 mm
- LXWXH : 158X54X135 CM



FL6012

DUMBBELL RACK

- Paint Finish : Electrostatic Powder Coating
- Unique adjustable Lower base in order to accommodate dumbbell of different sizes / types
- Pipe Size : 100x50x2.5 mm
- LXWXH : 208X53X81 CM

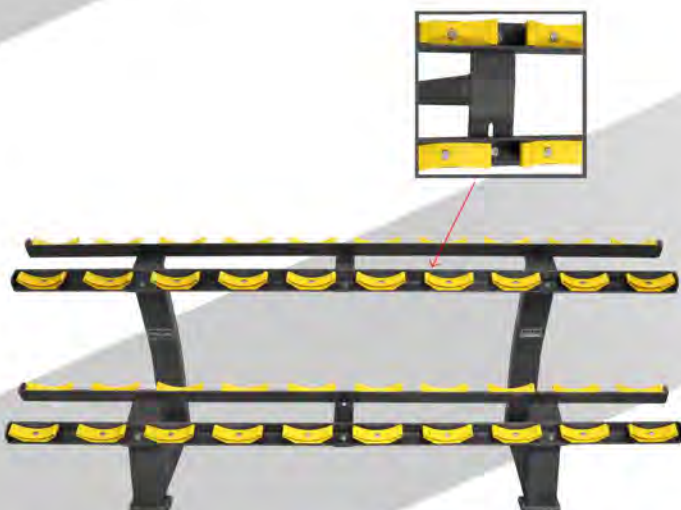

FL6013

MULTI AB BENCH

- Paint Finish : Electrostatic Powder Coating
- Seats : Tear resistant leatherite
- Pipe Size : 100x50x2.5 mm
- LXWXH : 178X69X92 CM



FL6014

OLYMPIC FLAT BENCH

- Paint Finish : Electrostatic Powder Coating
- Seats : Tear resistant leatherite
- Pipe Size : 100x50x2.5 mm
- LXWXH : 170X159X137 CM



FL6015

OLYMPIC INCLINE BENCH

- Paint Finish : Electrostatic Powder Coating
- Seats : Tear resistant leatherite
- Pipe Size : 100x50x2.5 mm
- LXWXH : 178X159X151 CM



FL6016

OLYMPIC DECLINE BENCH

- Paint Finish : Electrostatic Powder Coating
- Seats : Tear resistant leatherite
- Pipe Size : 100x50x2.5 mm
- LXWXH : 195X159X137 CM



FL6018

DUMBBELL RACK

- Paint Finish : Electrostatic Powder Coating
- Pipe Size : 100x50x2.5 mm
- LXWXH : 200X51X80 CM



FL6019

INCLINE T BAR

- Paint Finish : Electrostatic Powder Coating
- Seats : Tear resistant leatherite
- Pipe Size : 100x50x2.5 mm
- LXWXH : 188X99X122 CM



FL6020

FID BENCH

- Paint Finish : Electrostatic Powder Coating
- Seats : Tear resistant leatherite
- Pipe Size : 100x50x2.5 mm
- LXWXH : 145X51X132 CM



FL6021

SUPER SQUAT

- Paint Finish : Electrostatic Powder Coating
- Seats : Tear resistant leatherite
- Pipe Size : 100x50x2.5 mm
- LXWXH : 190X175X185 CM



FL6022

UTILITY BENCH

- Paint Finish : Electrostatic Powder Coating
- Seats : Tear resistant leatherite
- Pipe Size : 100x50x2.5 mm
- LXWXH : 101X81X88 CM



FL6024

DELUXE UTILITY STOOL

- Paint Finish : Electrostatic Powder Coating
- Seats : Tear resistant leatherite
- Pipe Size : 100x50x2.5 mm
- LXWXH : 120X81X88 CM



FL6041

4 WAY OLYMPIC BENCH

- Unique Flat / Incline / Decline / Shoulder position
- Paint Finish : Electrostatic Powder Coating
- Seats : Tear resistant leatherite
- Pipe Size : 100x50x2.5 mm
- LXWXH : 167X172X163 CM



FL6063

3 TIER DUMBBELL RACK

- Paint Finish : Electrostatic Powder Coating
- Pipe Size : 100x50x2.5 mm
- LXWXH : 175X81X92 CM



FL6064

PLATE TREE

- Paint Finish : Electrostatic Powder Coating
- Pipe Size : 100x50x2.5 mm
- LXWXH : 82X68X133 CM



FL6033

HALF RACK

- Paint Finish : Electrostatic Powder Coating
- Pipe Size : 100x50x2.5 mm
- LXWXH : 136X175X245 CM



FL6043

HALF RACK WITH PLATFORM

- Paint Finish : Electrostatic Powder Coating
- Pipe Size : 100x50x2.5 mm
- Rack Size : LXWXH : 136X175X245 CM
- Rubber tile thickness : 25mm
- Wooden board thickness : 25mm



IFHC

HALF CAGE

- This base system provides the ultimate in safety and exercise variety.
- Self spotting triple chromed bar racking system for safer free weight solo workouts.
- Includes multiple plate holders for convenient racking.
- Adjustable safety spotters accommodates:
- LXWXH : 118X182X209 CM.



IFHCS

HALF CAGE SMITH ATTACHMENT

- Optional for IF-HC.
- LXWXH : 195X30X173 CM.



IFSS

SQUAT STAND

- Self spotting triple chromed bar racking system for safer solo workouts.
- Angled uprights for better squat and bench exercises.
- Multiple plate holders for convenient storage.
- Adjustable safety spotters
- LXWXH : 123X128X174 CM.



IF45

45°HYPEREXTENSION

- Adjustable thigh pads for proper positioning and support.
- 45 degree angle for optimal results.
- Dual transport wheels for easy movement.
- LXWXH : 121X74X77 CM.



IFAAB

ADJUSTABLE ABDOMINAL BENCH

- Over sized bench padding for maximum comfort.
- Dual transport wheels for easy movement.
- LXWXH : 168X57X115 CM.



IFAC

ABDOMINAL CRUNCH

- Fixed decline angle for basic abdominal workout.
- LXWXH : 110X48X58 CM.



IFPT

POWER TOWER

- Contoured arm rests for secure positioning.
- Angled back pad for added comfort.
- Multiple grip positions for easy chin ups, dips, push ups and leg raise.
- LXWXH : 132X61X210 CM.



IFSPC

SEATED PREACHER CURL

- Bar catch design for easy re-racking.
- Adjustable oversized arm pad.
- LXWXH : 102X71X82 CM.



IFFB

FLAT BENCH

- Wide base for added safety.
- Dual rear transport wheels for easy movement.
- LXWXH : 130X53X49 CM.



IFFID

MULTI PURPOSE BENCH

- Dual rear transport wheels for easy movement.
- Quick and easy seat and back pad adjustments.
- Fully adjustable decline to shoulder press.
- LXWXH : 158X65X52 CM.



IFOB

OLYMPIC BENCH

- Excellent adjustable uprights.
- Expandable with drop in attachment. Options - IF-LEGA & IF-ARMA.
- Fully adjustable decline to shoulder press.
- LXWXH : 144X126X147 CM.



IFOIB

INCLINE BENCH

- LXWXH : 156X131X119 CM.



IFODB

DECLINE BENCH

- LXWXH : 190X131X115 CM



IFDB4

4FT HORIZONTAL DUMBBELL RACK

- For easy racking and unranking.
- Ideal for larger dumbbells sets.
- Can be converted into a 3 tier rack by adding IF-DB4A
- LXWXH : 137X47X87 CM.



IFDB4A

4FT DUMBBELL RACK 3RD TIER OPTION

- Optional for IF-DB4.
- LXWXH : 124X24X74 CM.



IFPTO

OLYMPIC PLATE TREE

- Unique design that optimises storage space.
- LXWXH : 84X83X111 CM.



ROBO ARM 22

FUNCTIONAL TRAINER

- STURDY DESIGN
- Weight stack : 200lbs x 2
- LXWXH : 246X359X249 cm



FTSM

FUNCTIONAL TRAINER CUM SMITH MACHINE

- STURDY DESIGN
- Weight stack : 200lbs x 2
- LXWXH : 258X102X248 CM



KH212

DUAL TWISTER

- Durable commercial grade construction.
- With Double Ball Bearings.
- Ergonomically Designed Handles.
- LXWXH : 137X47X127 CM.



KH270

SQUAT PLATFORM

- Sturdy Design.



KH271

SISSY SQUAT

- Sturdy Design.



KH303

BARBELL RACK

- Sturdy Design
- LXWXH : 44X44X17 CM



KH320

BICEP CURL STAND

- Commercial Grade.
- Sturdy Frame.
- Can store upto 6 Olympic hole plates.
- LXWXH : 122X46X73 CM



KH260

GORILLA GRIPPER / WRIST CURL

- Paint Finish : Electrostatic Powder Coating
- Seats : Tear resistant latherite
- Pipe Size : 100x50x2.5 mm
- Weight Stack : 60 KGS
- LXWXH : 58X57X103 CM



KH275

WRIST CURL

- Sturdy Design.
- Weight Stack : 175 lbs



KH280

WRIST CURL

- Paint Finish : Electrostatic Powder Coating
- Seats : Tear resistant latherite
- Pipe Size : 100x50x2.5 mm
- Weight Stack : 88 LBS
- LXWXH : 47X62X100 CM



KH285

STANDING LATERAL RAISE

- Commercial Grade.
- Sturdy Frame.
- Weight stack : 130 LBS.
- LXWXH : 145X81X150 CM



X75

FID BENCH

- Durable commercial grade construction.
- Heavy duty frame structure.
- Options of flat, incline & decline position.
- Can be used for multiple exercises.



X100

MULTI PURPOSE BENCH

- Flat, incline & decline position.
- With preacher curl attachment.
- With leg extension & prone leg curl.



X150

3 WAY OLYMPIC BENCH

- Flat, incline & decline position.
- With smooth & convenient seat adjustment.
- LXWXH : 241X188X142 CM.



X200

PLATE LOADED STRENGTH TRAINER

- DIMENSIONS : 175X170X220 CMS
- MAXIMUM WEIGHT LOADING CAPACITY : 120 KGS



X400

WALL MOUNTED FOLDABLE SQUAT RACK

- DIMENSIONS : 115X138X230 CMS
- MAXIMUM WEIGHT LOADING CAPACITY : 200 KGS



X500

HALF RACK

- DIMENSIONS : 126X180X232 CMS
- MAXIMUM WEIGHT LOADING CAPACITY : 200 KGS



X600

FUNCTIONAL RACK WITH LONG PULL

- DIMENSIONS : 154X170X232 CMS
- MAXIMUM WEIGHT LOADING CAPACITY : 120 KGS



X900

FTSM

- FUNCTIONAL TRAINER CUM SMITH MACHINE
- DIMENSIONS : 205X147X232 CMS
- WEIGHT STACK OF 80 KG X 2
- MAXIMUM WEIGHT LOADING CAPACITY : 200 KGS



SAVAGE

MULTI TRAINER

- FUNCTIONAL TRAINER CUM SMITH MACHINE CUM MULTI GYM
- DIMENSIONS : 180X219X227 CMS
- WEIGHT STACK OF 100 KG X 2
- MAXIMUM WEIGHT LOADING CAPACITY : 200 KGS



618LP ENDURANCE

HEAVY DUTY COMMERCIAL MULTI GYM

- State-of-the-art design with heavy duty steel structure
- 4 station gym with 3 steel weight stacks of 90 Kgs each
- Multiple Exercise Function – Leg press, Shoulder press, Chest press, Lat pull, Seated row and all high / low pulley exercises
- Comfortable seat pads
- All weight stacks attached at right angle for maximum space saving when placed in a corner
- Durable powder coated finish
- Arc cover for protection
- LXWXH : 269X239X216 CM



618EC POWER HOUSE

HEAVY DUTY COMMERCIAL MULTI GYM

- State-of-the-art design with heavy duty steel structure
- 4 station gym with 3 steel weight stacks of 90 Kgs each
- Multiple Exercise Function – Leg extension, Prone leg curl, Shoulder press, Chest press, Lat pull, Seated row and all high / low pulley exercises
- Comfortable seat pads
- All weight stacks attached at right angle for maximum space saving when placed in a corner
- Durable powder coated finish
- Arc cover for protection
- LXWXH : 269X239X216 CM

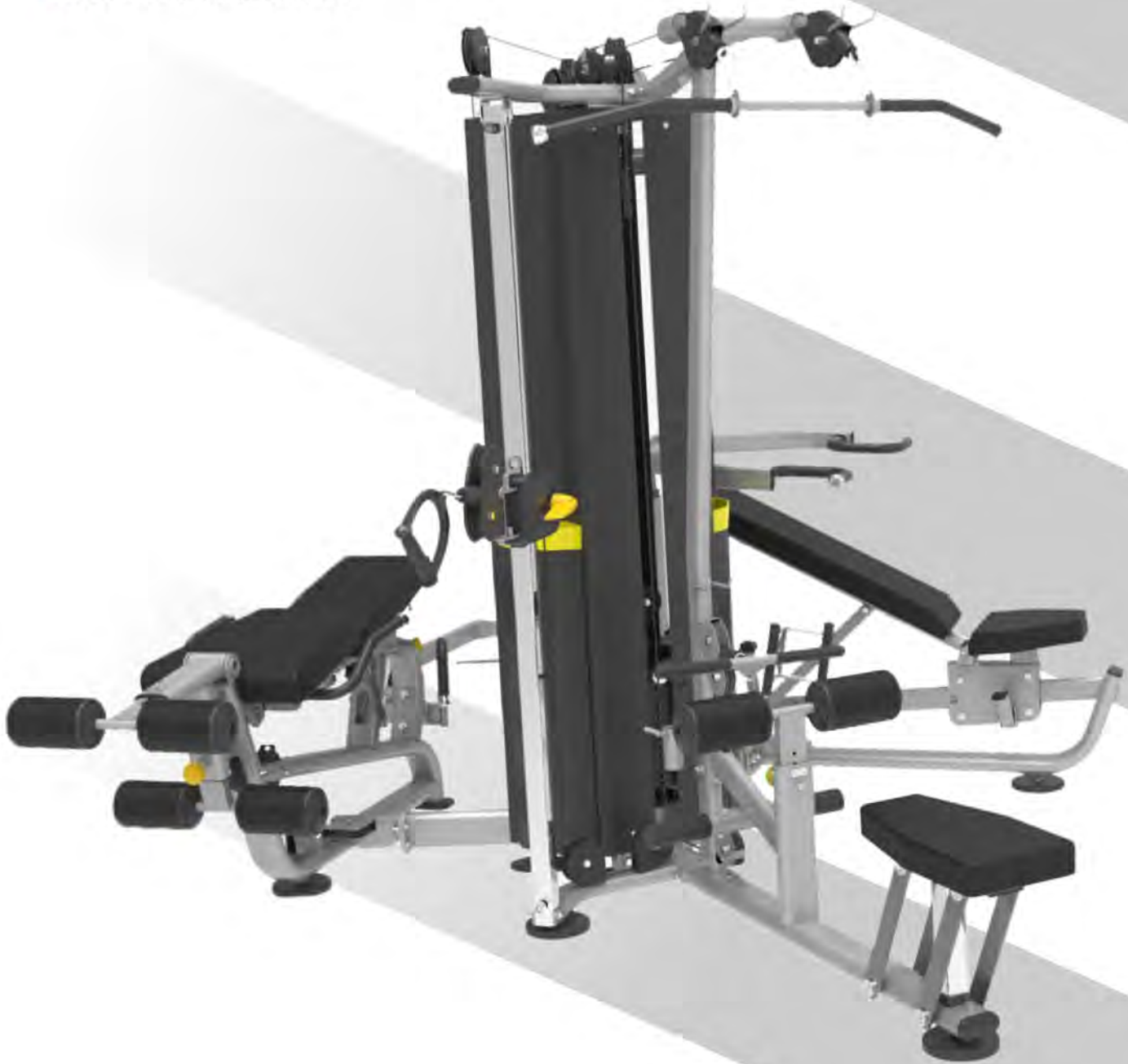

318LP

MULTI GYM

- Innovative design and ideal for corporate & society use
- Multi station gym with 1 steel weight stacks of 90 Kgs.
- Multiple Exercise Function – Seated bench press, Row, Pull down, Chest clamp, Tricep push down, Standing abdominal curl, Leg extension, Standing leg curl, Standing bicep curl, Golf, Arm extension, Front raise, Shrugs & Leg press.
- Durable powder coated finish
- Comfortable seat pads
- Arc cover for protection
- LXWXH : 219X222X213 CM



318MG

MULTI GYM

- Innovative design and ideal for corporate & society use
- Multi station gym with 1 steel weight stacks of 90 Kgs.
- Multiple Exercise Function – Seated bench press, Row, Pull down, Chest clamp, Tricep push down, Standing abdominal curl, Leg extension, Standing leg curl, Standing bicep curl, Golf, Arm extension, Front raise & Shrugs.
- Durable powder coated finish
- Comfortable seat pads
- Arc cover for protection
- LXWXH : 213X150X213 CM



418CA STAR

COMMERCIAL MULTI GYM

- Innovative design & ideal for corporate or society use.
- 6 station gym with 2 STEEL weight stacks of 70 Kgs each.
- Multiple Exercise Function - Leg extension, Leg press, Hi-Lo pulley, Tricep extension, Lat pull, Bicep curl, Pec Dec, Multi press, Abdominal crunch, Bicep curl, Bench press, Vertical knee raise, Chin up & Dips stand etc.
- Durable powder coated finish.
- Comfortable seat pads.
- Arc cover for protection.
- LXWXH : 332X244X230 CM.



418BA STELLA

LIGHT COMMERCIAL MULTI GYM

- Innovative design & ideal for corporate or society use.
- 5 station gym with 2 weight stacks of 90 Kgs & 65 Kgs each.
- Multiple Exercise Function - Leg extension, Leg press, Hi-Lo pully, Chin up, Lat pull, Bicep curl, Pec Dec, Multi press, Tricep extension, Abdominal crunch, Bicep curl, Bench press, Vertical knee raise etc.
- Durable power coated finish.
- Comfortable seat pads.
- Arc cover for protection.
- LXWXH : 332X240X230 CM.



518LC CHAMPION

LIGHT COMMERCIAL MULTI GYM

- 4 station gym with 4 weight stacks of 68 Kgs each.
- Exercise Function - Leg press, Chest press, Leg extension, Pec fly, Lat pull, Bicep curl, Rowing etc.
- Durable power coated finish.
- Ergonomic Design / Scientific Biomechanics.
- LXWXH : 250X250X220 CM



IMPULSE ZONE

Customized Group Functional Training



TOP VIEW



X-SHAPE

PRODUCT DIMENSION
7489x3139x2446 (mm)
294.8x123.6x96.3 (in)

ENERGY 360

WITH ACCESSORIES

● LXWXH : 450X400X250 CM.



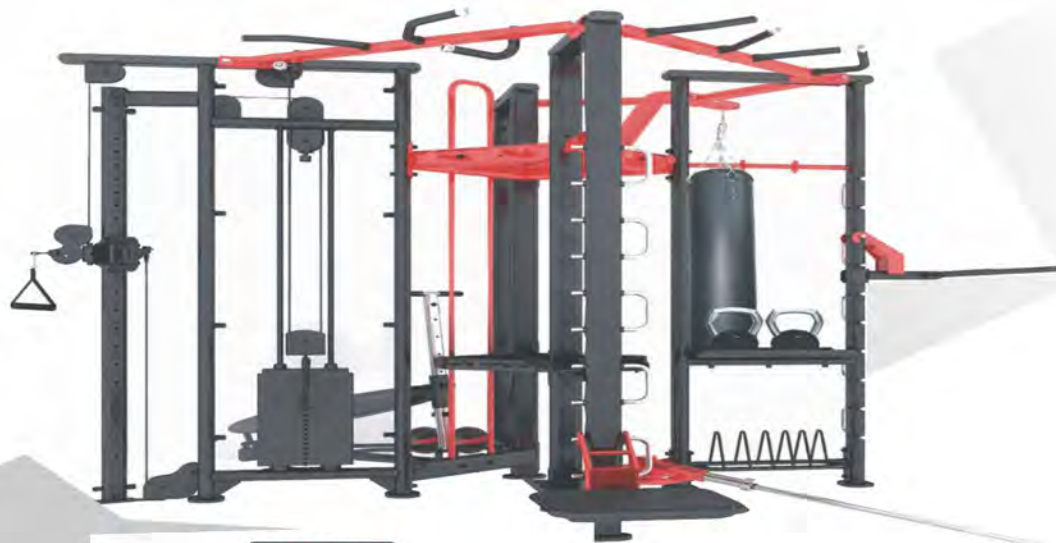

TOP VIEW

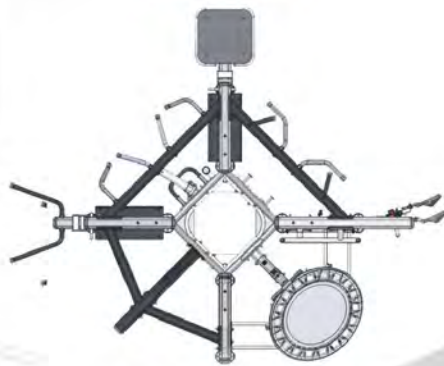

D-SHAPE

PRODUCT DIMENSION
 3235x2855x2400 (mm)
 127.3x112.4x94.4 (in)

KH308

SUSPENSION TRAINING RACK

- Sturdy Design.
- LXWXH : 312X206X251 CM.



WEIGHT LIFTING PLATFORM

- Extra heavy duty steel platform
- Platform size is 8'x6'
- Rubber tile thickness 30mm
- Board thickness 30mm
- Steel frame 50mm



WEIGHT LIFTING PLATFORM JUNIOR

- Heavy duty steel platform.
- Platform size is 8'x4'
- Rubber tile thickness 25mm
- Board thickness 20mm
- Steel frame 50mm



RUBBER COATED VIVA POWER FIXED BARBELLS WITH STRAIGHT AND CURL HANDLE BAR

- Made from high grade virgin rubber for long life.
- Dia 30mm and length 100cm.
- Tear proof, soundless & bouncy effect.

AVAILABLE SIZES
KGS
10
15
20
25
30
35
40



VIVA THERMO POWER SOLID DUMBBELLS

- Made from high grade thermoplastic rubber (TPR) for long life.
- Tear proof, soundless & bouncy effect.



AVAILABLE SIZES
KGS
2.5
5
7.5
10
12.5
15
17.5
20
22.5
25
30
35
40
45
50

VIVA POWER SOLID DUMBBELL

- Made from high grade virgin rubber for long life.
- Tear proof, soundless & bouncy effect.



AVAILABLE SIZES
KGS
2.5
5
7.5
10
12.5
15
17.5
20
22.5
25
27.5
30
35
40
45
50

VIVA FORCE DUMBBELLS

- Made from high grade rubber compound for long life.
- Tear proof, soundless & bouncy effect.



AVAILABLE SIZES
KGS
2.5
5
7.5
10
12.5
15
17.5
20
22.5
25
27.5
30
35
40

HEXAGON DUMBBELL

- Made from rubber for long life.
- Tear proof, soundless & bouncy effect.



AVAILABLE SIZES
KGS
2.5
5
7.5
10
12.5
15
17.5
20
25

COLOURED

BUMPER PLATES

- Made from high quality rubber.

AVAILABLE SIZES
KGS
5
10
15
20
25



VIVA FITNESS TPR

OLYMPIC HOLE PLATES

- Made from high grade thermoplastic rubber for long life.
- Tear proof, soundless & bouncy effect.



AVAILABLE SIZES
KGS
1.25
2.5
5
7.5
10
15
20
25

VIVA POWER

OLYMPIC HOLE PLATES

- Patented : Unique Anti Roll Design
- Made From Durable And Premium Grade Virgin Rubber
- Aesthetically Designed With Epdm Red Granules
- Ergonomically Designed Grips
- Long Lasting Aluminium Bushes



AVAILABLE SIZES

KGS
1.25
2.5
5
7.5
10
15
20
25

VIVA FORCE

OLYMPIC HOLE PLATES

- Made from high grade virgin rubber for long life.
- Tear proof, soundless & bouncy effect



AVAILABLE SIZES

KGS
1.25
2.5
5
7.5
10
15
20
25

NEOPRENE

KETTLE BELL



AVAILABLE SIZES

KGS
2
4
8
12
16
20
24
28
32

IR94088

STRONGMAN THICK BARBELL

- Unique 50 mm grip bar
- Hard chrome tempered alloy steel
- Max loading : 1600 lbs
- 7.2 ft olympic length.
- Net weight : 20 kgs.



IR101

COMPETITION OLYMPIC BAR

- Net weight : 20 kgs.
- 7.2 ft olympic length.
- Flexible barbell made from heat treated Spring Steel.
- High quality nickel chrome finish.
- Comes with 2 bronze bush & 4 needle bearing.
- Shaft diameter : 28mm.
- Sleeve diameter : 50mm.
- Shaft length : 51.5"
- Sleeve length : 15.2"
- Max. load capacity : 907 kg / 2000 Lbs.



IR94039

HEAVY DUTY OLYMPIC BAR

- Net weight : 20 kgs.
- 7.2 ft olympic length.
- Made from carbon steel.
- High quality nickel chrome finish.
- Shaft diameter : 30mm.
- Sleeve diameter : 50mm.
- Sleeve length : 14"
- Max. load capacity : 816 kg / 1800 Lbs.



IR94038

OLYMPIC BAR

- Net weight : 16 kgs.
- 7.2 ft olympic length.
- Made from carbon steel.
- High quality nickel chrome finish.
- Shaft diameter : 28mm.
- Sleeve diameter : 50mm.
- Sleeve length : 14"



IR94052

72" OLYMPIC BAR

- Net weight : 13 kgs.
- High quality nickel chrome finish.
- Shaft diameter : 28mm.
- Sleeve diameter : 50mm.
- Sleeve length : 11".



IR94051

60" OLYMPIC BAR

- Net weight : 11 kgs.
- High quality nickel chrome finish.
- Shaft diameter : 28mm.
- Sleeve diameter : 50mm.
- Sleeve length : 10".



IR94048

48" OLYMPIC BAR

- Net weight : 10 kgs.
- High quality nickel chrome finish.
- Shaft diameter : 28mm.
- Sleeve diameter : 50mm.
- Sleeve length : 8".



IR94047

47" EZ CURL BAR

- Net weight : 10 kgs.
- High quality nickel chrome finish.
- Shaft diameter : 28mm.
- Sleeve diameter : 50mm.
- Sleeve length : 8".



IR102

MULTI GRIP BAR

- Size : 2.2 meter



IR94083

56" OLYMPIC BAR



IR94025

14" REGULAR RUBBER
HANDLE HOLLOW BAR

• Matches our small hole rubber plates



IR94045

OB20" OLYMPIC BAR



IR94046

OLYMPIC TRICEP BAR



IR94064

OLYMPIC BAR COLLAR (PLASTIC)



IR95069

NYLON LAT ROPE



IR94061

COLLAR



IR95017

38" SOLID LAT BAR



IR95015

48" SOLID LAT BAR



IR95021



IR95020

20" SOLID LAT BAR



IR95023



IR95022



IR95025



IR95024



IR95019



IR95026



IR95029



IR94084



IR95028



IR94089

OLYMPIC BAR PIVOT



IR103

ROPE TRAINER

- Unique cardio workout
- Adjustable resistance control



IR94090

T BAR HANDLE



POUND PAD



IR111

DOUBLE DEADLIFT JACK



IR110

DEADLIFT MINI JACK



FLIP TYRE

- Large Dia tyre made from pre-used rubber
- Develops Power and Strength
- Good for Functional Training
- FTU100 (100 kgs.)
- FTU70 (70 kgs)
- FTU50 (50 kgs)



SLED WITH TYRES



WEIGHT SLED HYPER PRO

- Heavy metal Construction with Shoulder Harness
- Good for all Push Pull
- Drag Sports & Speed Training
- All Fold-able for Easy Transportation
- Dual side operational



WEIGHT SLED HYPER

- Heavy metal Construction with Shoulder Harness
- Good for all Push Pull
- Drag Sports & Speed Training
- All Fold-able for Easy Transportation
- Dual side operational



WEIGHT SLED TRIO

- Heavy metal Construction
- Must for all Push Pull Drag Sports & Speed Training
- Good for all Push Pull
- Drag Sports & Speed Training
- All Fold-able for Easy Transportation
- Dual side operational



WEIGHT SLED MINI

- Metal Construction with Shoulder Hardness
- Must for all Push Pull Drag Sports & Speed Training
- Good for all Push Pull
- Drag Sports & Speed Training
- All Fold-able for Easy Transportation
- Dual side operational



NJ-1004

LADDER BARREL

The Pilates Ladder Barrel is unique. It offer both active and passive back extension exercises. Of course as with all the pilates equipment it is designed to allow many other exercises to be performed.

The Pilates Equipment barrels are excellent for developing back strength and promoting trunk extension which is crucial to developing good posture.

Pilates Barrels utilize gravity rather than springs for resistance.



NJ-1006A

SPINE CORRECTOR

The Spine Corrector is the ultimate piece of equipment for aligning and mobilising the spine and can also contribute to an improved posture. As a diverse Pilates tool, it can also be used to perform exercises lengthening and strengthening the torso, shoulders, back and legs while correcting or restoring the spine's natural curvature.



OUR CLIENTS...



WE DESIGN YOUR FITNESS PROJECT



GYM DESIGN

Our in-house professional design team create gym layout and propose interior schemes to maximise your investment potential in terms of user demand and diversity. Making the best use of available space and incorporating natural features, branding and equipment selection, these are visualized 2D and 3D format with full 3D-rendered animations also available.

A COMPLETE SOLUTION

With more than 16 years experience of running of our own gyms plus unrivalled business planning, operational and management experience, Viva Fitness has the know-how to plan & budget your project along with the hands-on management, qualified expertise and staffing resources to partner you every step of the way towards your ultimate success.



SCAN FOR DOWNLOADING
THE COMPLETE CATALOGUE



Push Yourself



MARKETED IN INDIA BY :

Soccer International Private Limited

www.vivafitness.net www.tunturiindia.com www.californiafitness.in



* All pictures / models are indicative only * Design and price is subject to change without prior notice * Conditions apply * GST extra